

Compact IPM Series Dual Module 400 Amperes/600 Volts

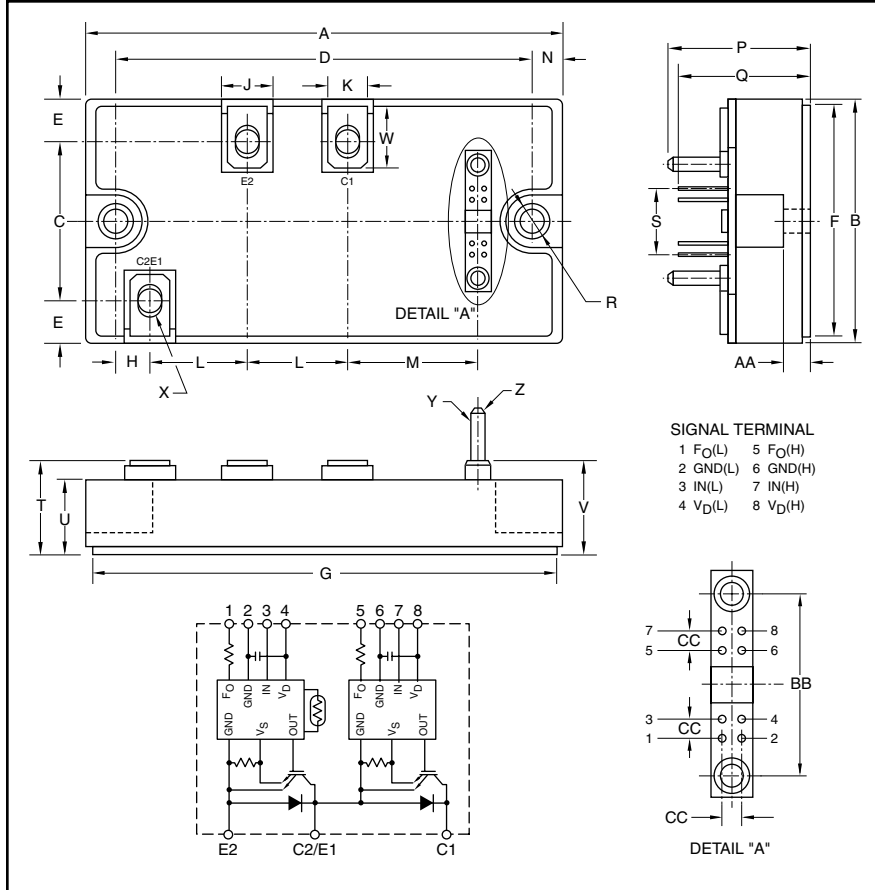

Description:

Powerex Dual Compact IPM Series Modules are designed for use in switching applications. Each module consists of two IGBT Transistors in a half-bridge configuration, with each transistor having a reverse-connected super-fast recovery free-wheel diode. All components and interconnects are isolated from the heat sinking baseplate, offering simplified system assembly and thermal management.

Features:

- Over-Current and Over-Temperature Protection
- Low V_{CE(sat)}
- Isolated Baseplate for Easy Heat Sinking

Applications:

- AC Motor Control
- Motion/Servo Control
- UPS
- Welding Power Supplies
- Laser Power Supplies

Ordering Information:

MIG400J2CSB1W is a 600V (V_{CE(s)}), 400 Ampere Compact IPM Series Dual Module.

Outline Drawing and Circuit Diagram

Dimensions	Inches	Millimeters
A	4.21±0.04	107.0±1.0
B	2.16±0.04	55.0±1.0
C	1.42±0.03	36.0±0.8
D	3.66±0.01	93.0±0.3
E	0.37±0.03	9.5±0.8
F	2.05±0.02	52.0±0.5
G	4.09±0.02	104.0±0.5
H	0.29±0.03	7.5±0.8
J	0.47	12.0
K	0.35	9.0
L	0.87±0.03	22.0±0.8
M	1.15±0.03	29.24±0.8
N	0.28	7.0
P	1.32±0.04/-0.02	33.5±1.0/-0.5

Dimensions	Inches	Millimeters
Q	1.24±0.03	31.5±0.8
R	0.22 Dia.	5.5 Dia.
S	0.6	15.24
T	0.87±0.04/-0.01	22.0±1.0/-0.3
U	0.73±0.03	18.5±0.8
V	0.89±0.04/-0.024	22.0±1.0/-0.6
W	0.55	13.9
X	M5 Metric	M5
Y	0.12 Dia.	3.0 Dia.
Z	0.025 Sq.	0.64 Sq.
AA	0.28	7.0
BB	1.0±0.024	25.4±0.6
CC	0.1	2.54



Powerex, Inc., 200 E. Hillis Street, Youngwood, Pennsylvania 15697-1800 (724) 925-7272

MIG400J2CSB1W
Compact IPM Series Dual Module
400 Amperes/600 Volts

Absolute Maximum Ratings, $T_j = 25^\circ\text{C}$ unless otherwise specified

Characteristics	Symbol	MIG400J2CSB1W	Units
Power Device Junction Temperature	T_j	-20 to 150	$^\circ\text{C}$
Storage Temperature	T_{stg}	-40 to 125	$^\circ\text{C}$
Operating Temperature	T_C	-20 to 100	$^\circ\text{C}$
Mounting Torque, M5 Mounting Screws	—	31	in-lb
Module Weight (Typical)	—	278	Grams
Isolation Voltage, AC 1 minute, 60Hz Sinusoidal	V_{ISO}	2500	Volts

IGBT Inverter Sector

Supply Voltage (P-N Power Terminal)	V_{CC}	450	Volts
Collector-Emitter Voltage	V_{CES}	600	Volts
Collector Current ($T_C = 25^\circ\text{C}$, DC)	I_C	400	Amperes
Forward Current ($T_C = 25^\circ\text{C}$, DC)	I_F	400	Amperes
Collector Power Dissipation ($T_C = 25^\circ\text{C}$)	P_C	2190	Watts

IGBT Control Sector

Control Supply Voltage (V_D -GND Terminal)	V_D	20	Volts
Input Voltage (IN-GND Terminal)	V_{IN}	20	Volts
Fault Output Voltage (F_O -GND (L) Terminal)	V_{FO}	20	Volts
Fault Output Current (F_O Sink Current)	I_{FO}	10	mA



Powerex, Inc., 200 E. Hillis Street, Youngwood, Pennsylvania 15697-1800 (724) 925-7272

MIG400J2CSB1W
Compact IPM Series Dual Module
 400 Amperes/600 Volts

Electrical and Mechanical Characteristics, $T_j = 25^\circ\text{C}$ unless otherwise specified

Characteristics	Symbol	Test Conditions	Min.	Typ.	Max.	Units
IGBT Inverter Sector						
Collector Cut-off Current	I_{CEX}	$V_{CE} = 600\text{V}, T_j = 25^\circ\text{C}$	—	—	1	mA
		$V_{CE} = 600\text{V}, T_j = 125^\circ\text{C}$	—	—	10	mA
Collector-Emitter Saturation Voltage	$V_{CE(sat)}$	$V_D = 15\text{V}, I_C = 400\text{A}, V_{IN} = 15\text{V to } 0\text{V}, T_j = 25^\circ\text{C}$	1.6	1.9	2.3	Volts
Saturation Voltage		$V_D = 15\text{V}, I_C = 400\text{A}, V_{IN} = 15\text{V to } 0\text{V}, T_j = 125^\circ\text{C}$	—	2.1	—	Volts
Forward Voltage	V_F	$I_F = 400\text{A}, T_j = 25^\circ\text{C}$	—	2.3	2.7	Volts
Switching Time	t_{on}		—	2.0	3.0	μs
	$t_{c(on)}$	$V_{CC} = 300\text{V}, I_C = 400\text{A},$	—	0.4	—	μs
	t_{rr}	$V_D = 15\text{V}, V_{IN} = 15\text{V} \leftrightarrow 0\text{V},$	—	0.2	—	μs
	t_{off}	$T_j = 25^\circ\text{C}, \text{ Inductive Load}$	—	1.5	2.5	μs
	$t_{c(off)}$		—	0.25	—	μs
Control Sector						
Control Circuit Current	$I_{D(H)}$	High Side, $V_D = 15\text{V}$	—	13	17	mA
	$I_{D(L)}$	Low Side, $V_D = 15\text{V}$	—	13	17	mA
Input-ON Signal Voltage	$V_{IN(on)}$	$V_D = 15\text{V}$	1.4	1.6	1.8	Volts
Input-OFF Signal Voltage	$V_{IN(off)}$	$V_D = 15\text{V}$	2.2	2.5	2.8	Volts
Fault Output Current	$I_{FO(on)}$	Protection Current, $V_D = 15\text{V}$	—	10	12	mA
	$I_{FO(off)}$	Normal Current, $V_D = 15\text{V}$	—	—	0.1	mA
Over-Current Protection Trip Level	O_C	$V_D = 15\text{V}, T_j \leq 125^\circ\text{C}$	640	—	—	Amperes
Short-Circuit Current	S_C	$V_D = 15\text{V}, T_j \leq 125^\circ\text{C}$	640	—	—	Amperes
Protection Trip Level						
Over-Current Cut-off Time	$t_{off(OC)}$	—	—	5	—	μs
Over-Temperature	O_T	Trip Level Case Temperature	110	118	125	$^\circ\text{C}$
Protection	O_{Tr}	Reset Level Case Temperature	—	98	—	$^\circ\text{C}$
Control Supply Under Voltage Protection	U_V	Trip Level	11.0	12.0	12.5	Volts
	U_{Vr}	Reset Level	12.0	12.5	13.0	Volts
Fault Output Pulse Width	$t_d(FO)$	$V_D = 15\text{V}$	1	2	3	ms



Powerex, Inc., 200 E. Hillis Street, Youngwood, Pennsylvania 15697-1800 (724) 925-7272

MIG400J2CSB1W
Compact IPM Series Dual Module
400 Amperes/600 Volts

Thermal Characteristics

Characteristic	Symbol	Condition	Min.	Typ.	Max.	Units
Junction to Case	$R_{th(j-c)Q}$	IGBT (Per 1/2 Module)	—	—	0.057	°C/Watt
Thermal Resistance	$R_{th(j-c)D}$	FWDi (Per 1/2 Module)	—	—	0.130	°C/Watt
Contact Thermal Resistance	$R_{th(c-f)}$	—	—	0.017	—	°C/Watt

Recommended Conditions for Use

Characteristic	Symbol	Condition	Min.	Typ.	Max.	Units
Supply Voltage	V_{CC}	P-N Power Terminals	—	300	400	Volts
Control Supply Voltage	V_D	V_D -GND Signal terminal	13.5	15	16.5	Volts
Switching Frequency	f_C	PMW Control	—	—	20	kHz
Dead Time*	t_{DEAD}	—	5	—	—	µs

*The table lists Dead Time requirements for the module input, excluding photocoupler delays. When specifying Dead Time requirements for the photocoupler input, please add photocoupler delays to the Dead Time given above.



Powerex, Inc., 200 E. Hillis Street, Youngwood, Pennsylvania 15697-1800 (724) 925-7272

MIG400J2CSB1W
Compact IPM Series Dual Module
 400 Amperes/600 Volts

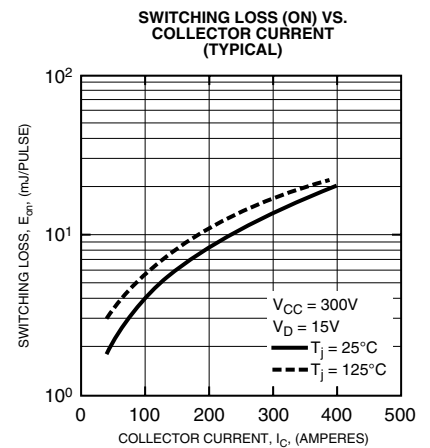
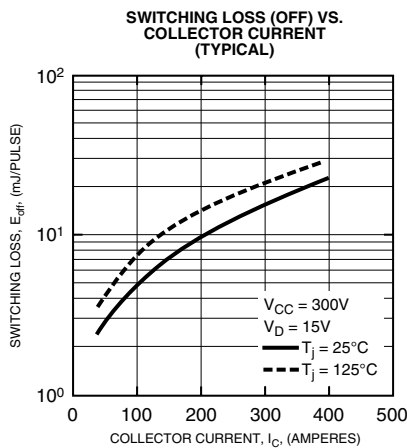
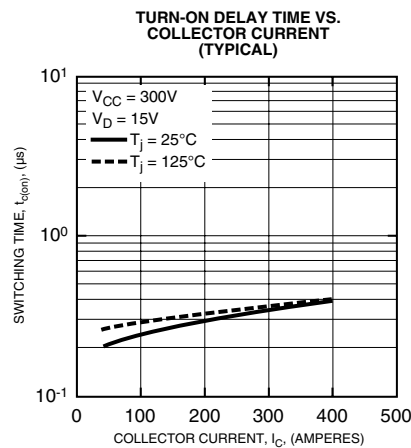
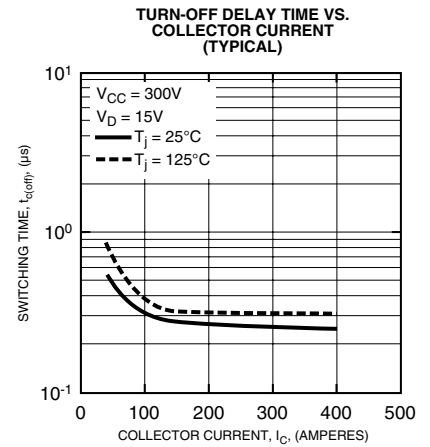
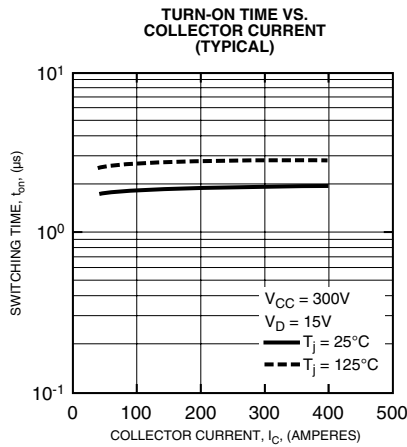
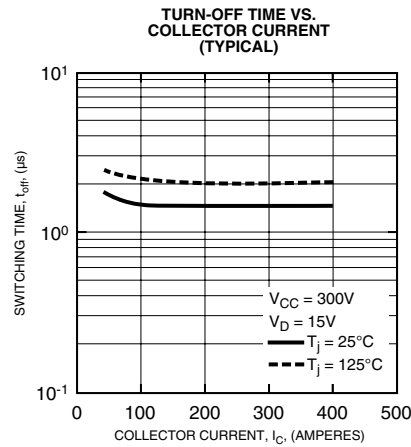
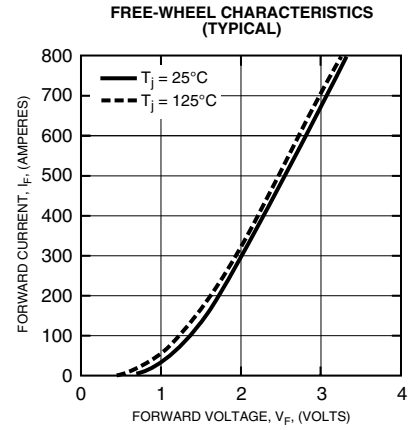
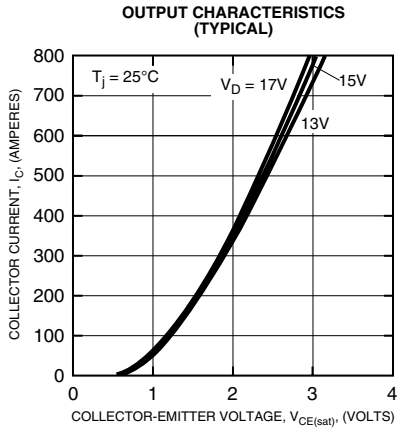
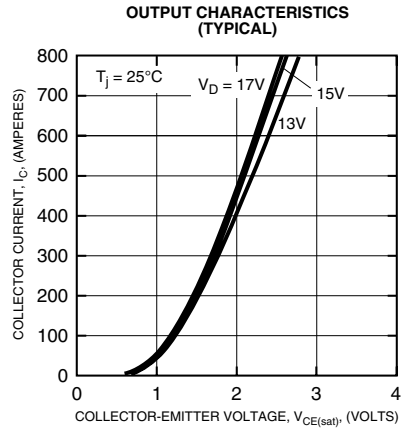



Powerex, Inc., 200 E. Hillis Street, Youngwood, Pennsylvania 15697-1800 (724) 925-7272

MIG400J2CSB1W
Compact IPM Series Dual Module
 400 Amperes/600 Volts

