

User Manual

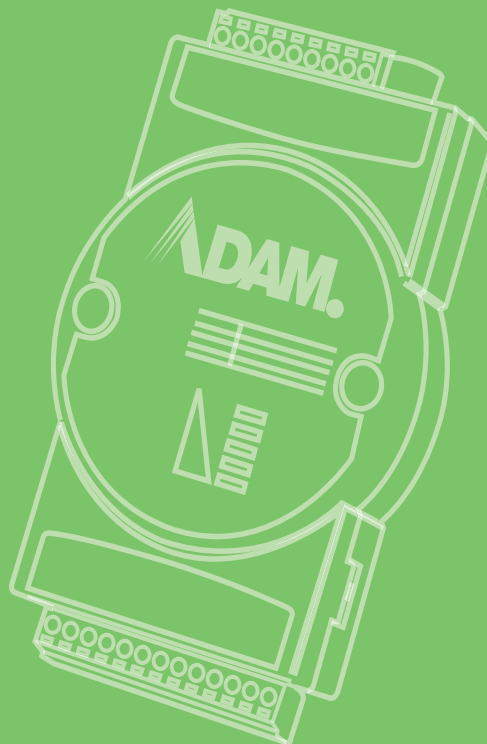

ADAM-2000 Series

Wireless Sensor Network Data
Acquisition Modules

ADVANTECH

eAutomation

Copyright

The documentation and the software included with this product are copyrighted 2012 by Advantech Co., Ltd. All rights are reserved. Advantech Co., Ltd. reserves the right to make improvements in the products described in this manual at any time without notice. No part of this manual may be reproduced, copied, translated or transmitted in any form or by any means without the prior written permission of Advantech Co., Ltd. Information provided in this manual is intended to be accurate and reliable. However, Advantech Co., Ltd. assumes no responsibility for its use, nor for any infringements of the rights of third parties, which may result from its use.

Acknowledgements

Intel and Pentium are trademarks of Intel Corporation.

Microsoft Windows and MS-DOS are registered trademarks of Microsoft Corp.

All other product names or trademarks are properties of their respective owners.

Product Warranty (2 years)

Advantech warrants to you, the original purchaser, that each of its products will be free from defects in materials and workmanship for two years from the date of purchase.

This warranty does not apply to any products which have been repaired or altered by persons other than repair personnel authorized by Advantech, or which have been subject to misuse, abuse, accident or improper installation. Advantech assumes no liability under the terms of this warranty as a consequence of such events.

Because of Advantech's high quality-control standards and rigorous testing, most of our customers never need to use our repair service. If an Advantech product is defective, it will be repaired or replaced at no charge during the warranty period. For out-of-warranty repairs, you will be billed according to the cost of replacement materials, service time and freight. Please consult your dealer for more details.

If you think you have a defective product, follow these steps:

1. Collect all the information about the problem encountered. (For example, CPU speed, Advantech products used, other hardware and software used, etc.) Note anything abnormal and list any onscreen messages you get when the problem occurs.
2. Call your dealer and describe the problem. Please have your manual, product, and any helpful information readily available.
3. If your product is diagnosed as defective, obtain an RMA (return merchandise authorization) number from your dealer. This allows us to process your return more quickly.
4. Carefully pack the defective product, a fully-completed Repair and Replacement Order Card and a photocopy proof of purchase date (such as your sales receipt) in a shippable container. A product returned without proof of the purchase date is not eligible for warranty service.
5. Write the RMA number visibly on the outside of the package and ship it prepaid to your dealer.

Declaration of Conformity

FCC

This equipment has been tested and found to comply with the limits for a Class B digital device, pursuant to part 15 of the FCC Rules. These limits are designed to provide reasonable protection against harmful interference in a residential installation. This equipment generates, uses and can radiate radio frequency energy and, if not installed and used in accordance with the instructions, may cause harmful interference to radio communications. However, there is no guarantee that interference will not occur in a particular installation. If this equipment does cause harmful interference to radio or television reception, which can be determined by turning the equipment off and on, the user is encouraged to try to correct the interference by one or more of the following measures:

- Reorient or relocate the receiving antenna.
- Increase the separation between the equipment and receiver.
- Connect the equipment into an outlet on a circuit different from that to which the receiver is connected.
- Consult the dealer or an experienced radio/TV technician for help.

CE

This product has passed the CE test for environmental specifications when shielded cables are used for external wiring. We recommend the use of shielded cables. This kind of cable is available from Advantech. Please contact your local supplier for ordering information.

CE

This product has passed the CE test for environmental specifications. Test conditions for passing included the equipment being operated within an industrial enclosure. In order to protect the product from being damaged by ESD (Electrostatic Discharge) and EMI leakage, we strongly recommend the use of CE-compliant industrial enclosure products.

Technical Support and Assistance

1. Visit the Advantech web site at www.advantech.com/support where you can find the latest information about the product.
2. Contact your distributor, sales representative, or Advantech's customer service center for technical support if you need additional assistance. Please have the following information ready before you call:
 - Product name and serial number
 - Description of your peripheral attachments
 - Description of your software (operating system, version, application software, etc.)
 - A complete description of the problem
 - The exact wording of any error messages

Warnings, Cautions and Notes

Warning! Warnings indicate conditions, which if not observed, can cause personal injury!



Caution! Cautions are included to help you avoid damaging hardware or losing data. e.g.



There is a danger of a new battery exploding if it is incorrectly installed. Do not attempt to recharge, force open, or heat the battery. Replace the battery only with the same or equivalent type recommended by the manufacturer. Discard used batteries according to the manufacturer's instructions.

Note! Advantech reserves the right to change this manual at any time without notice.



Document Feedback

To assist us in making improvements to this manual, we would welcome comments and constructive criticism. Please send all such - in writing to: support@advantech.com

Packing List

Before setting up the system, check that the items listed below are included and in good condition. If any item does not accord with the table, please contact your dealer immediately.

- 1x ADAM-2000 Series Device
- 1x 2dBi Antenna (ADAM-2520Z, ADAM-2510Z, ADAM-2051PZ and ADAM-2017PZ only)
- 2 x Mounting Kits
- 1x CD

Safety Instructions

1. Read these safety instructions carefully.
2. Keep this User Manual for later reference.
3. Disconnect this equipment from any AC outlet before cleaning. Use a damp cloth. Do not use liquid or spray detergents for cleaning.
4. For plug-in equipment, the power outlet socket must be located near the equipment and must be easily accessible.
5. Keep this equipment away from humidity.
6. Put this equipment on a reliable surface during installation. Dropping it or letting it fall may cause damage.
7. The openings on the enclosure are for air convection. Protect the equipment from overheating. **DO NOT COVER THE OPENINGS.**
8. Make sure the voltage of the power source is correct before connecting the equipment to the power outlet.

9. Position the power cord so that people cannot step on it. Do not place anything over the power cord.
10. All cautions and warnings on the equipment should be noted.
11. If the equipment is not used for a long time, disconnect it from the power source to avoid damage by transient overvoltage.
12. Never pour any liquid into an opening. This may cause fire or electrical shock.
13. Never open the equipment. For safety reasons, the equipment should be opened only by qualified service personnel.
14. If one of the following situations arises, get the equipment checked by service personnel:
 15. The power cord or plug is damaged.
 16. Liquid has penetrated into the equipment.
 17. The equipment has been exposed to moisture.
 18. The equipment does not work well, or you cannot get it to work according to the user's manual.
 19. The equipment has been dropped and damaged.
 20. The equipment has obvious signs of breakage.
21. DO NOT LEAVE THIS EQUIPMENT IN AN ENVIRONMENT WHERE THE STORAGE TEMPERATURE MAY GO BELOW -40°C (-40°F) OR ABOVE 85°C (185°F). THIS COULD DAMAGE THE EQUIPMENT. THE EQUIPMENT SHOULD BE IN A CONTROLLED ENVIRONMENT.
22. CAUTION: DANGER OF EXPLOSION IF BATTERY IS INCORRECTLY REPLACED. REPLACE ONLY WITH THE SAME OR EQUIVALENT TYPE RECOMMENDED BY THE MANUFACTURER, DISCARD USED BATTERIES ACCORDING TO THE MANUFACTURER'S INSTRUCTIONS.
23. The sound pressure level at the operator's position according to IEC 704-1:1982 is no more than 70 dB (A).

DISCLAIMER: This set of instructions is given according to IEC 704-1. Advantech disclaims all responsibility for the accuracy of any statements contained herein.

Safety Precaution - Static Electricity

Follow these simple precautions to protect yourself from harm and the products from damage.

Disconnect power before making any configuration changes. The sudden rush of power as you connect a jumper or install a card may damage sensitive electronic components.

Contents

Chapter 1	Understanding Your System	1
1.1	Introduction	2
	Figure 1.1 ADAM-2000 Series System Architecture.....	2
	Figure 1.2 ADAM-2000 Series Operating Distance	2
1.1.1	IEEE 802.15.4 Wireless Standard	3
	Table 1.1: Wireless Specifications.....	3
1.1.2	Wireless Sensor Network.....	3
1.1.3	Low-power Consumption and Battery-Powered Design	4
1.1.4	Sensor Embedded Design	4
1.1.5	Wireless Signal Indicator	4
1.1.6	Industrial Standard Modbus Protocol.....	4
1.1.7	SCADA Software Support.....	4
1.1.8	Advantech Software Alignment.....	4
1.2	Specifications	5
1.2.1	ADAM-2000 Series Hardware Specification	5
1.2.2	LED Status.....	6
	Figure 1.3 LED Indicators	6
	Table 1.2: LED Indicator Definitions	6
1.2.3	Wireless Communication Range.....	7
1.2.4	Selecting Topology	10
	Table 1.3: Topology Comparison Table	10
1.3	Dimensions	11
	Figure 1.4 ADAM-2000 Series Dimensions	11
1.4	Mounting	12
1.4.1	Panel Mounting	12
	Figure 1.5 Panel Mounting Dimensions.....	12
1.4.2	DIN-rail Mounting	13
	Figure 1.6 Fixing ADAM-2000 to DIN rail adaptor	13
	Figure 1.7 Fixed ADAM-2000 to DIN rail	13
1.5	Wiring & Connections.....	14
1.5.1	Power Supply Wiring.....	14
	Figure 1.8 Power Wiring Diagram.....	14
1.5.2	I/O Module Wiring	15
1.5.3	Communication Wiring.....	15
	Figure 1.9 RS-422/485 and USB interface of ADAM-2520Z.	15
	Figure 1.10Wiring Diagram for ADAM-2520Z.....	16
Chapter 2	Selecting Your Hardware	17
2.1	Selecting an ADAM-2000 Module	18
2.1.1	Selecting a Communication Module	18
	Table 2.1: Communication Module Selection Guidelines	18
2.1.2	Selecting an I/O	19
	Table 2.2: I/O Selection Guidelines	19
2.1.3	Selecting a Sensor Module	19
	Table 2.3: Sensor Mode Selection	19
2.2	Selecting an Operator Interface	20
Chapter 3	Module Introduction	21
3.1	Communication Modules.....	22
3.1.1	ADAM-2510Z	22
3.1.2	ADAM-2520Z	23

3.2	I/O and Sensor Modules	24
3.2.1	ADAM-2017PZ.....	24
	Figure 3.1 Current Input Wiring Diagram of ADAM-2017PZ	26
	Figure 3.2 Voltage Input Wiring Diagram of ADAM-2017PZ	26
3.2.2	ADAM-2031Z.....	27
3.2.3	ADAM-2051Z.....	29
3.2.4	ADAM-2051PZ.....	30
	Figure 3.3 ADAM-2051Z/2051PZ Wet Contact Diagram.....	31
	Figure 3.4 ADAM-2051Z/2051PZ Dry Contact Diagram	31

Chapter 4 Installation Guide 33

4.1	Determining the Proper Environment.....	34
4.1.1	Package Contents	34
4.1.2	System Requirements	34
4.1.3	Perform a Wireless Sensor Network.....	34
	Figure 4.1 The Architecture of the Wireless Sensor Network....	35
4.2	Establish the Connection	36
4.2.1	Basic Installation.....	36
	Figure 4.2 Multi-End Device Network performance	38
	Figure 4.3 Multi-End Device and Router Network Relationship	39
4.2.2	ADAM-2000 Series Installation Flowcharts	39
	Figure 4.4 ADAM-2000 Installation Chart.....	40
4.3	Advanced Functions	44
4.3.1	Link Quality Indicator	44
	Table 4.1: Level of LQI	44
4.3.2	Battery Level.....	44
	Table 4.2: Level of battery power	44
4.3.3	Pairing.....	45
4.3.4	Associating Devices.....	45
4.3.5	Reboot	45
4.3.6	Button Function Table.....	45
	Table 4.3: Button Functions	45
4.4	Conduct a Site Survey	46
4.4.1	Before Going Onsite	46
4.4.2	Onsite Survey	46

Chapter 5 Software Configuration Guide 47

5.1	System Software Configuration Utility.....	48
5.2	Installing AdamApax .NET Utility Software	48
5.3	AdamApax .NET Utility Operation	48
	Figure 5.1 AdamApax .NET Utility Operation Window	48
	Figure 5.2 AdamApax .NET Utility Toolbar.....	50
5.3.1	USB Driver Installation.....	51
5.3.2	Search and Configure the ADAM-2000 Series	51
	Figure 5.3 ADAM-2000 Series AdamApax .NET Utility Support	51
	Figure 5.4 Search the USB interface ADAM-2000 devices on the	
	host PC for the virtual COM port.	52
	Figure 5.5 Search the COM port for the ADAM-2000 devices. .	52
	Figure 5.6 Searching the network dialog	53
	Figure 5.7 Searching the ADAM-2000 coordinators.....	53
	Figure 5.8 ADAM-2000 devices lists on the Tree View and Infor-	
	mation page.....	54
	Figure 5.9 The overview of ADAM-2000 end devices.	55
	Figure 5.10The overview of ADAM-2000 routers	55
	Figure 5.11Information page of ADAM-2520Z.....	56
	Figure 5.12Wireless Configuration page of the ADAM-2520Z. .	56
	Figure 5.13 Information page of ADAM-2510Z.....	57

	Figure 5.14 Wireless Configuration page of ADAM-2510Z.....	58
	Figure 5.15 The Device Status page of the ADAM-2510Z	58
	Figure 5.16 Information Page	59
	Figure 5.17 Wireless Configuration page	60
	Figure 5.18 The Device Status page	60
	Figure 5.19 The Signal page	61
5.3.3	Network Topology of ADAM-2000 Series	62
	Figure 5.20 Topology of the ADAM-2000 series.....	62
	Figure 5.21 Topology of ADAM-2000 network with specific back-ground image.....	62
5.3.4	Module Locate Function of ADAM-2000 Series (Except ADAM-2520Z).....	63
	Figure 5.22 Node Tree.....	63
5.3.5	Group Configuration.....	64
	Figure 5.23 Group Configuration	64
	Figure 5.24 Firmware Update in Group Configuration.....	64
	Figure 5.25 Wireless Setting of Group Configuration	65

Chapter A ADAM-2000 Series Functions.....67

A.1	Introduction	68
A.2	ADAM-2000 I/O Modbus Mapping Table	68
	Table A.1: Modbus ID Table of ADAM-2000 series	68
A.2.1	ADAM-2520Z	69
	Table A.2: ADAM-2520Z Mapping Table	69
A.2.2	ADAM-2510Z	70
	Table A.3: ADAM-2510Z Mapping Table	70
A.2.3	ADAM-2017PZ.....	71
	Table A.4: ADAM-2017PZ Mapping Table.....	71
A.2.4	ADAM-2031Z	74
	Table A.5: ADAM-2031Z Mapping Table	74
A.2.5	ADAM-2051Z	76
	Table A.6: ADAM-2051Z Mapping Table	76
A.2.6	ADAM-2051PZ.....	77
	Table A.7: ADAM-2051PZ Mapping Table.....	77

Chapter B Troubleshooting79

B.1	Troubleshooting	80
B.2	Notice	81

Chapter 1

Understanding Your
System

1.1 Introduction

ADAM-2000 series is the wireless solution of the ADAM families and integrates the IEEE 802.15.4 standard, I/O and Sensor technologies known as Wireless Sensor Network. Different from the wired solution, the flexible network capability makes it easy to extend or construct a cost-effective distributed monitoring system for variety of applications. Through popular industrial Modbus protocol, the ADAM-2000 can be integrated into any HMI and SCADA system. The low-power consumption design also makes it possible for standalone applications with batteries. The sensor embedded design provides compact size for specified application. With the ADAM-4000 and ADAM-6000, the ADAM provides the total solutions of remote I/O. Please refer to Figure 1-1 for a brief overview of the ADAM-2000 system architecture..

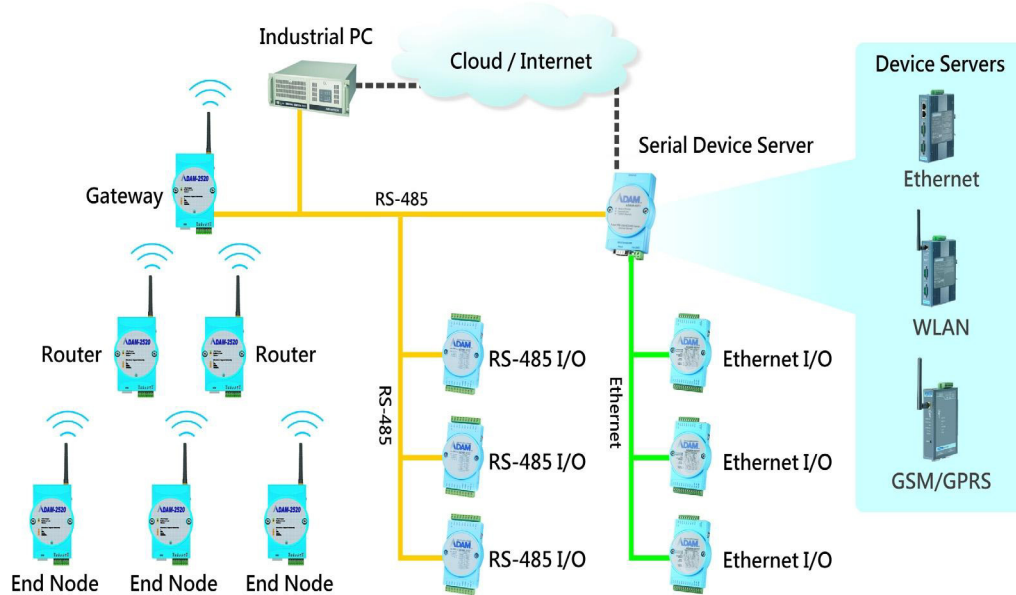

Figure 1.1 ADAM-2000 Series System Architecture

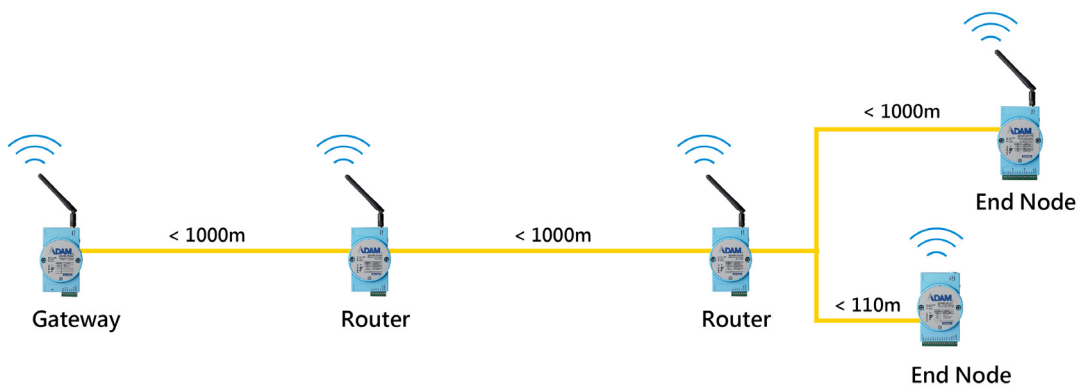

Figure 1.2 ADAM-2000 Series Operating Distance

1.1.1 IEEE 802.15.4 Wireless Standard

IEEE 802.15.4 is a wireless standard defined as Low Rate Wireless Personal Area Network (LR-WPAN) or usually called Wireless Personal Area Network (WPAN) instead. It is designed for low-power consumption and robust wireless communication, especially for small data packet applications, such as sensor, I/O and etc. IEEE 802.15.4 is a low data rate, low power consumption, low cost, wireless networking protocol targeted towards automation and remote control applications. It is expected to provide low cost and low power connectivity for equipment that needs battery life as long as several months to several years but does not require data transfer rates as high as those enabled by Bluetooth. The IEEE 802.15.4 standard only defines the PHY and MAC layers. The working RF are 868MHz for EU, 918MHz for USA and 2.4GHz for World Wide.

Table 1.1: Wireless Specifications

Feature(s)	IEEE 802.11b	Bluetooth	IEEE 802.15.4
Data Rate	11Mbps	1Mbps	250Kbps
Power Consumption	Hours (High)	Days	Years (Low)
Connection	Very Complex	Complex	Simple
Connection Speed	Up to 3 seconds	Up to 10 seconds	30ms
Extendibility	Roaming possible	No	Yes
Reliability	Low	High	High

1.1.2 Wireless Sensor Network

The Wireless Sensor Network is based on the IEEE 802.15.4 standard and inherits all the characteristics. Coordinator, Router and End Device (or called End Node) are the basic components to perform the PAN.

A coordinator is the data collection center in a PAN and also plays as a gateway to transfer and translate wireless data to other interfaces, such as RS-232, RS-485, Ethernet and so on.

A router is a wireless repeater to enhance the wireless signal and a wireless router to select optimized path for wireless communication between coordinator and end nodes.

An end node is a wireless remote I/O for data acquisition. The data acquires from sensors or devices can be transmitted through it. The end node can communicate with coordinator directly or via a router to coordinator.

As traditional network, the Wireless Sensor Network provides the star, tree and mesh topologies for various applications.

1.1.3 Low-power Consumption and Battery-Powered Design

ADAM-2000 is designed as a standalone device for applications that require long-time operation without maintenance. Therefore power consumption taken into consideration during its design. The ADAM-2000 not only follows the IEEE 802.15.4 standard for low-power consumption wireless communication, but also optimizes the peripheral HW and FW design to achieve the uA-level power consumption: making it capable of being powered using 2 AA batteries.

Note!



1. When Device adopts batteries for main power source, long network disconnection or association fail which will cause device into network reassociation mechanism then sharply reduce battery life.
2. For the choice of battery, we suggest Energizer L91 Ultimate Lithium AA battery.

1.1.4 Sensor Embedded Design

Sensor embedded design makes the ADAM-2000 even better in some specified and compact applications. The ADAM-2031Z integrates a temperature and a humidity sensor. The module is suitable for building automation, Green-house, environment applications which require the specified sensors. With the batteries installed into the ADAM-2031Z no extra wiring is required to power the module.

1.1.5 Wireless Signal Indicator

There are LEDs in the front of the panel to display the status of device. The LEDs can indicate the device's status, wireless signal strength, battery power level and error conditions. With the LEDs, users can easily check the status of the ADAM-2000 by pressing a button on the side of the ADAM-2000.

1.1.6 Industrial Standard Modbus Protocol

Modbus is an industrial standard serial communication protocol, and a commonly available way of connecting industrial electronic devices. Modbus allows for communication between many devices connected to the same network. Modbus RTU is used in serial communication and makes use of a compact binary representation of the data for protocol communication. The RTU format follows the commands/data with a cyclic redundancy check checksum as an error check mechanism to ensure the reliability of data.

1.1.7 SCADA Software Support

ADAM-2000 supports industrial standard Modbus protocol and can be integrated into Advantech HMI- WOP, SCADA - WebAccess and 3rd party HMI. With the different ADAM-2000 modules, it is able to acquire signal from digital input, analog input, temperature, humidity and concentration then the signals can be apply to your application.

1.1.8 Advantech Software Alignment

As with all other ADAM devices, the ADAM-2000 series is integrated into the AdamA-pax .NET Utility, therefore users will have an identical user experience. With the powerful Advantech software, only a few steps are required to search and configure the ADAM-2000 series.

1.2 Specifications

1.2.1 ADAM-2000 Series Hardware Specification

- IEEE Standards: IEEE 802.15.4
- Modulation Type: OQPSK
- Frequency Band: 2.4GHz ~ 2.4835GHz
- Channels: 11 - 26
- RF Data Rate: 250 kbps
- Transmit Power: 3dBm (1.6mW), 15dBm(20mW) & 19dBm(79mW)
- Receiver Sensitivity: -97 dBm
- Transmission Power:
 - ADAM-2031Z, ADAM-2051Z: 3 ± 1 dBm
 - ADAM-2017PZ: 15 ± 1 dBm
 - ADAM-2051PZ, ADAM-2510Z, ADAM-2520Z: 19 ± 1 dBm
- Outdoor Range (Line of Sight *):
 - ADAM-2031Z, ADAM-2051Z: 110m
 - ADAM-2017PZ, ADAM-2051PZ, ADAM-2510Z, ADAM-2520Z: 1000m
- Topology: Star/Tree/Mesh
- Range Extenders: Maximum 5 Hops
- Operating Temperature Range: -20°C ~ 70°C (-4°F ~ 157.9°F)
- Operating Temperature Range (Battery Powered): 0°C ~ 50°C (32°F~122°F)
- Storage Temperature: -40°C ~ 85°C (-40°F~185°F)
- Operation Humidity: 20% ~ 95%
- Storage Humidity: 0% ~ 95%

Note! * Outdoor Range is estimated with line of sight. The real transmitting distance would be affected by the environment of application site. Please perform site survey to determine the set up range of wireless network.



1.2.2 LED Status

There are four types of LED status on the front panel of ADAM-2000 series.

1. Ext PWR: Green LED
2. Error: Red LED
3. Status: Yellow LED
4. Level Index: 4x Amber LEDs

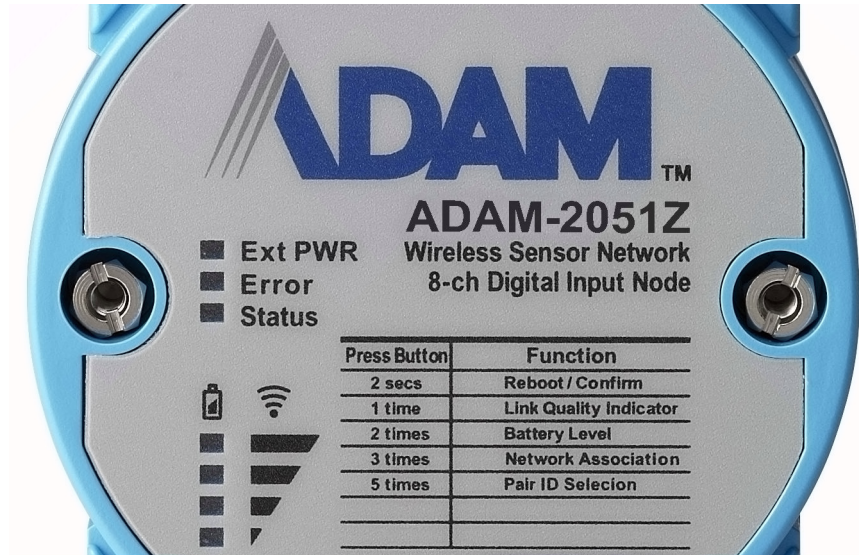

Figure 1.3 LED Indicators

Table 1.2: LED Indicator Definitions

Name	Color	LED Status	Definition
1	Green	On	External/USB Power Input
		Off	No External/USB Power Input
2	Red	Blinking	Network Connecting
		On	Error, refer to Appendix B for more information
		Off	No error
3	Yellow	On	Initial Mode
		Off	Normal Mode
		Blinking	Configure Pairing ID (Initial Mode)
4	Amber	On	Pair ID
		Off	No LQI / Battery Level
		Blinking	LQI Level and Battery Level

1.2.3 Wireless Communication Range

Though the wireless technology brings the advantage of flexibility, cost-effective wiring and easy deployment, but users must understand its limitations to enjoy the benefits of the wireless technology.

The Link Quality Indicator (LQI) of the ADAM-2000 displays how the facts below affect the wireless signal. Its indicator represents the Received Signal Strength Indication (RSSI) and the retransmission times of a packet. The better the LQI, the better the wireless data packet transmission quality. The limitation of the wireless communication range depends on following factors:

■ Transmission power	■ Receiver sensitivity
■ Interference	■ Line of Sight
■ Antenna Performance	■ Shelter
■ Altitude above Ground	■ Free Space Loss

1.2.3.1 Line of Sight

The distance of each node is defined as the clear path between the antennas which known as line of sight. Anything within the path will interrupt the radio transmission that interference the communication. Beware of the trees, buildings, moving objects, or other obstacles in between the antennas.



1.2.3.2 Multi-path and Reflection of Signal

When the modules used in indoor place, beware of the signal reflection. The reflection can help the signal cross the obstacle. It can also generate the multi-paths which will also cause signal attenuation. This is the reason why the transmission distance may be reduced in indoor place.

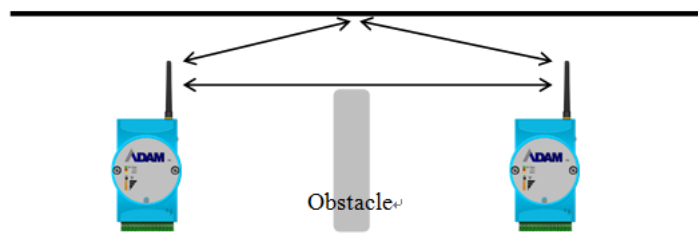

1.2.3.3 Distance between Different Types of Modules

Following figure demonstrate the transmission distance between each type of modules. The distance between the modules with power amplifier can be around 1000m under clear line of sight. But if the module without power amplifier is used here, the distance will be restricted by the power of the antenna of the module. So the path will be around 110m.

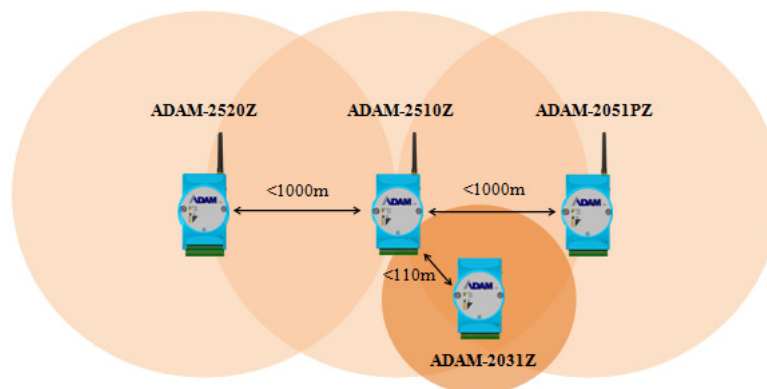

1.2.3.4 ADAM-2000 Antenna Pattern

The antenna of the modules with power amplifier uses the Omni-directional antenna. Its antenna pattern looks like a doughnut as the figure on the left below. The cross-sectional view of the antenna pattern is on the right below. The plane vertical to antenna has stronger signal, but the region on or under the antenna has lower signal. The modules including: ADAM-2520Z, ADAM-2510Z, ADAM-2017PZ, and ADAM-2051PZ.

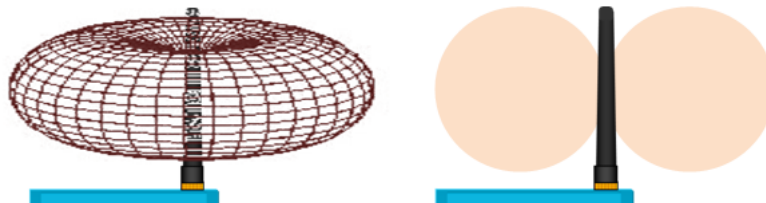

The modules without power amplifier use a build-in antenna inside the module. The build-in antenna is shown as a white bar on the left figure below. Its antenna pattern is also looks like a doughnut which vertical to antenna. The modules including: ADAM-2031Z and ADAM-2051Z.



For improving better performance of signal, user may need to adjust the angle of the antenna to change the antenna pattern. Beware of the relationship of the angle between position of router and end-devices.

The transmission distance of the modules is defined under the condition of clear line of sight. Following are the top view of antenna. The modules with power amplifier has less than 1000 m distance as the figure on the left, and the modules without power amplifier are less than 110 m.

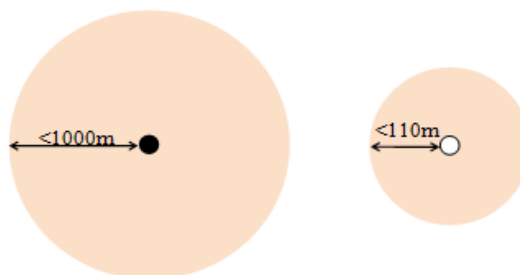

1.2.4 Selecting Topology

Usually, when building a network solution, the user has to take into consideration the topology that will be used since different topologies have different characteristics. The ADAM-2000 series provides star, tree and mesh topologies. No further configuration is required, the ADAM-2000 series will automatically associate the network by the locations of the ADAM-2000 series units. Users may select the correct topology and install ADAM-2000s for their application systems. The topology is depend on the number and the position of routers. See the image below and Table 1.3 provide the illustrations and characteristics comparison table of the three topologies.

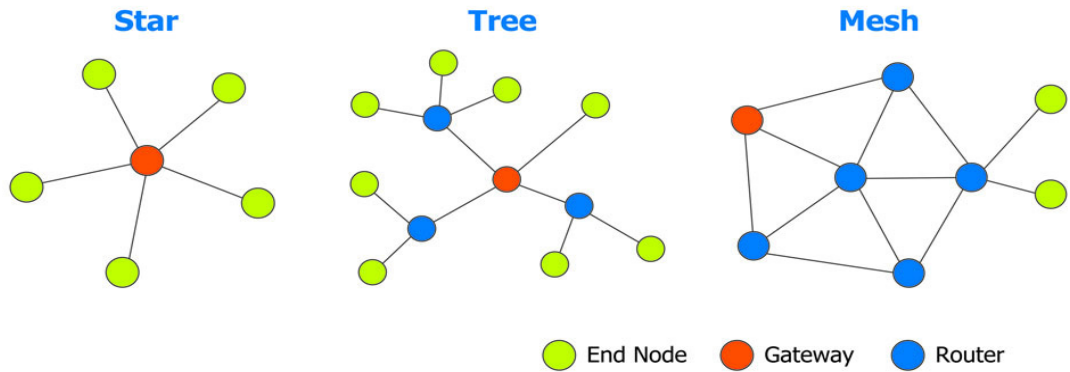

Table 1.3: Topology Comparison Table

Topology	Star	Tree	Mesh
Power Consumption	Low	Medium	High
Installation Fee	Low	Medium	High
Network Coverage	Small	Large	Large
Network Capability	Small	Large	Large

1.3 Dimensions

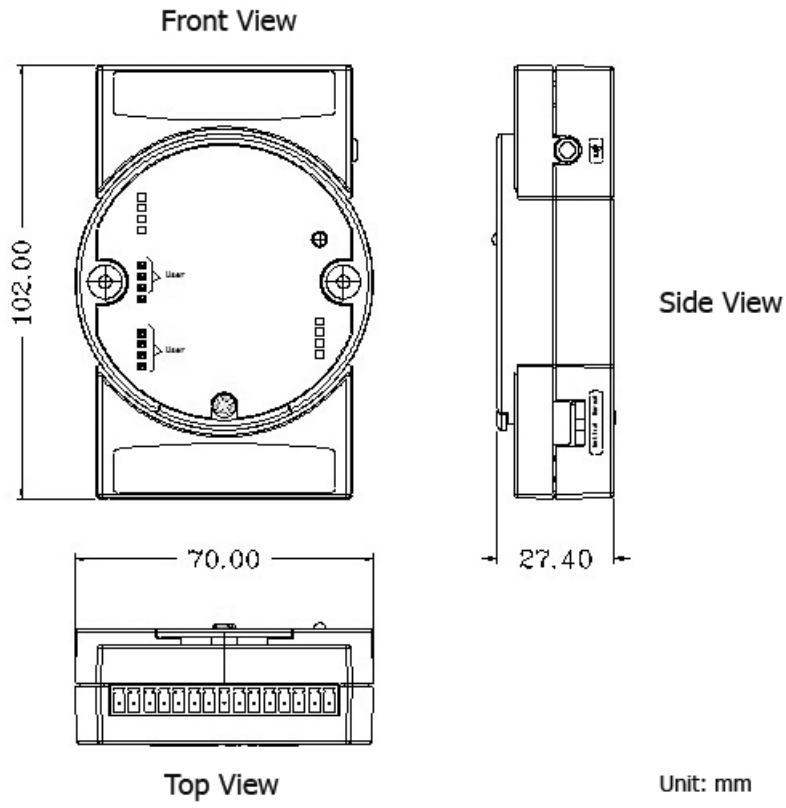

Figure 1.4 ADAM-2000 Series Dimensions

1.4 Mounting

ADAM-2000 series modules are designed as compact units and are allowed to be installed in the field site with the following methods.

1.4.1 Panel Mounting

Each ADAM-2000 Module is packed with a plastic panel mounting bracket. Users can refer the dimensions of the bracket to configure an optimal placement in a panel or cabinet. Fix the bracket first, then, fix the ADAM-2000 module on the bracket.

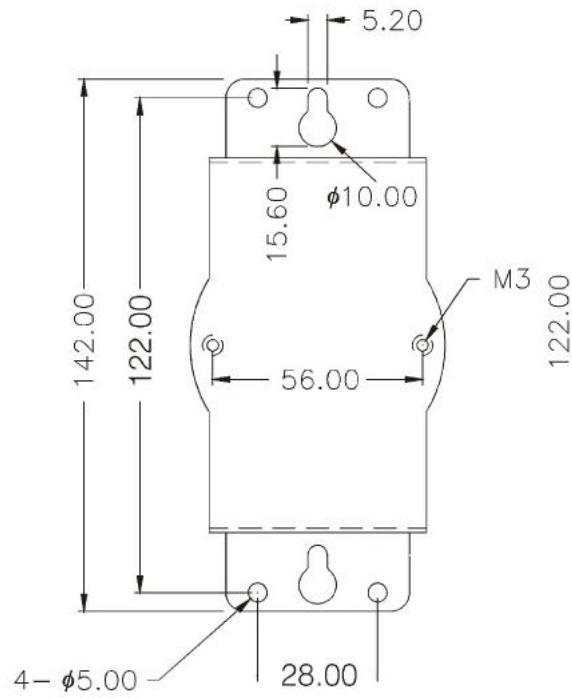

Figure 1.5 Panel Mounting Dimensions

1.4.2 DIN-rail Mounting

The ADAM-2000 module can also be secured to the cabinet by using mounting rails. Fix the ADAM-2000 module with the DIN-rail adaptor as Figure 1.6. Then secure it on the DIN-rail as Figure 1.7. If you mount the module on a rail, you should also consider using end brackets at each end of the rail. The end brackets help keep the modules from sliding horizontally along the rail.

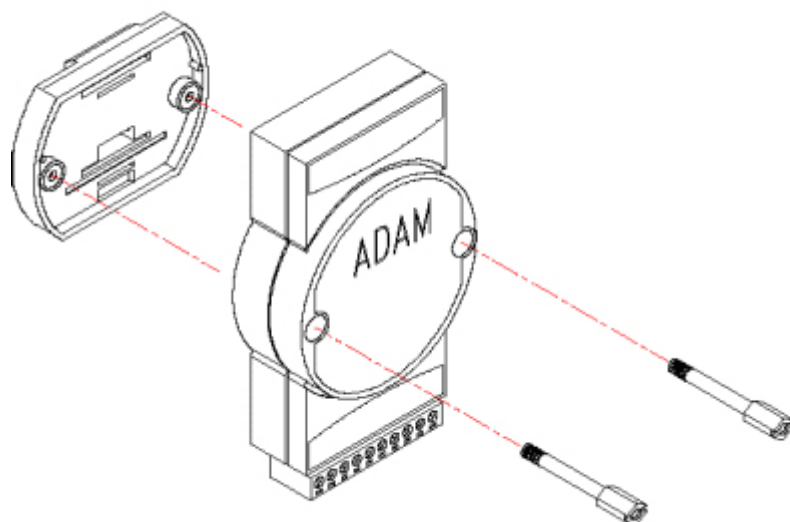

Figure 1.6 Fixing ADAM-2000 to DIN rail adaptor

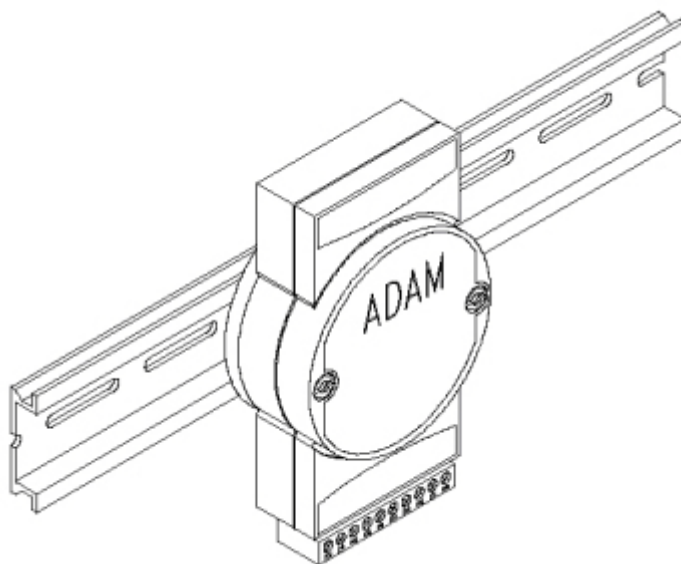

Figure 1.7 Fixed ADAM-2000 to DIN rail

1.5 Wiring & Connections

This section provides basic information of wiring the power supply, I/O units, communication units, and network connection.

1.5.1 Power Supply Wiring

You can choose power supply type with 3 types: external power terminal, USB port, and battery for ADAM-2520Z gateway, other devices can use external power or battery to get power.

1.5.1.1 External Power Input

Although the ADAM-2000 systems are designed for a standard industrial unregulated 24 V_{DC} power supply, they accept any power unit that supplies within the range of +10 to +30 V_{DC}. The power supply ripple must be limited to 200mV peak-to-peak, and the immediate ripple voltage should be maintained between +10 and +30 V_{DC}. Screw terminals +Vs and GND are for power supply wiring.

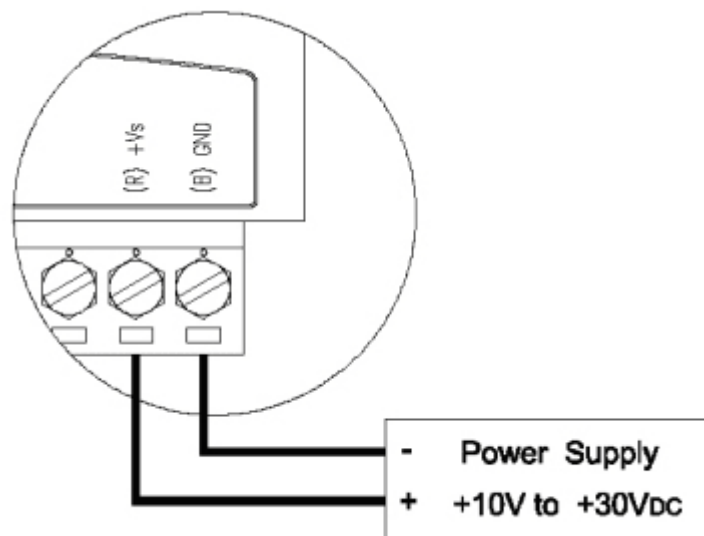

Figure 1.8 Power Wiring Diagram

1.5.1.2 ADAM-2520Z Basic Configuration with USB Power Supply

To use the USB cable as a power supply from a PC, connect the A Type USB connector to the computer and the other end (USB Type B) to the ADAM-2520Z Gateway.

1.5.1.3 Battery Power Slot

The ADAM-2000 series can be powered by batteries. Remove the name plate in the front of the ADAM-2000 series device and install 2 AA batteries for backup power or standard operation (depends on the power consumption of the devices). The ADAM-2000 is powered by batteries only if the external power is not available.

Note! The batteries will not be charged when using external input power.



Note! *If both external power input and battery power exist at the same time, that external power will have high priority of main power source.*



Note! *ADAM-2510Z router and ADAM-2520Z gateway are always in normal transmission mode during operation, and which power consumption will be higher than other end devices to shorten battery life, therefore, suggest ADAM-2510Z and ADAM-2520Z adopt external power input for main power source and battery power for backup power source.*



1.5.2 I/O Module Wiring

The system uses a plug-in screw terminal block as the interface between I/O modules and external devices. When connecting external devices to the I/O modules, follows the guideline below.

1. The maximum wire diameter allowed for the terminal block is 0.5 mm to 2.5 mm.
2. Always use an integrity wire.
3. Keep wires as short as possible.
4. Use wire trays or wire holders to secure wires.
5. Avoid running wires close to high energy wiring.
6. Keep input wiring and output wiring apart.
7. Avoid any sharp bend to the wires.
8. Follow the (+) and (-) symbols on the side panel to wire correctly.

1.5.3 Communication Wiring

In a WPAN, only the Gateway needs to connect to a host. The ADAM-2520Z is the Wireless Sensor Network Modbus RTU Gateway of the ADAM-2000 series and provides RS-422/485 and USB interfaces to connect to host. Users can choose one of the interfaces by pushing the switch to RS-422/485 or USB position.



Figure 1.9 RS-422/485 and USB interface of ADAM-2520Z.

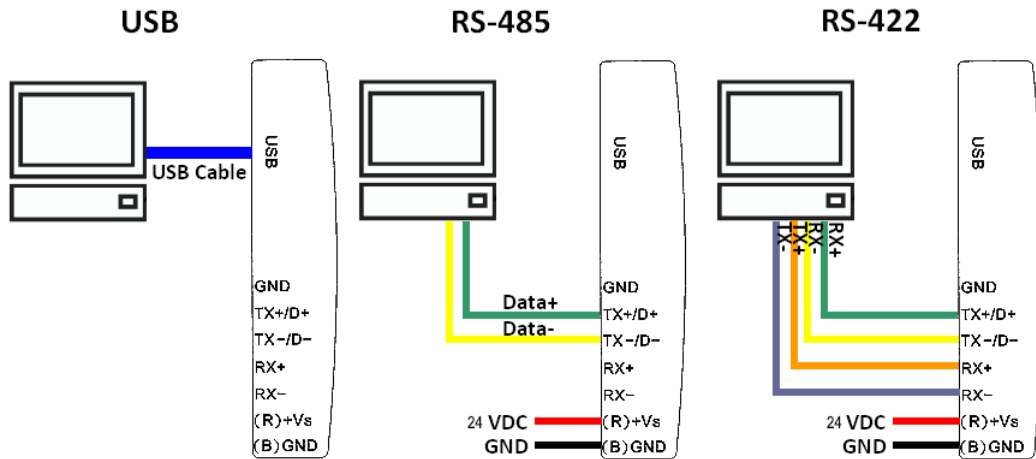
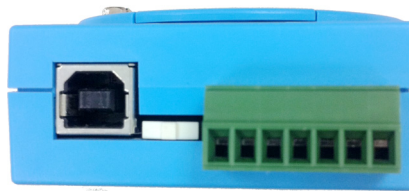

Figure 1.10 Wiring Diagram for ADAM-2520Z

When you want to set up ADAM-2520Z gateway, please see as a wireless receiver to use USB or RS-485 to do data transfer between router or end-device.



Note! On the base of ADAM-2520Z:



1. Move the switch to the left to select USB as main communication interface.
2. Move the switch to the right to select RS-485 as main communication interface.

For ADAM-2520Z, we recommend user to choose power source according to its communication interface. Please avoid the operation that insert USB power source and external power source at the same time.

Chapter 2

Selecting Your
Hardware

2.1 Selecting an ADAM-2000 Module

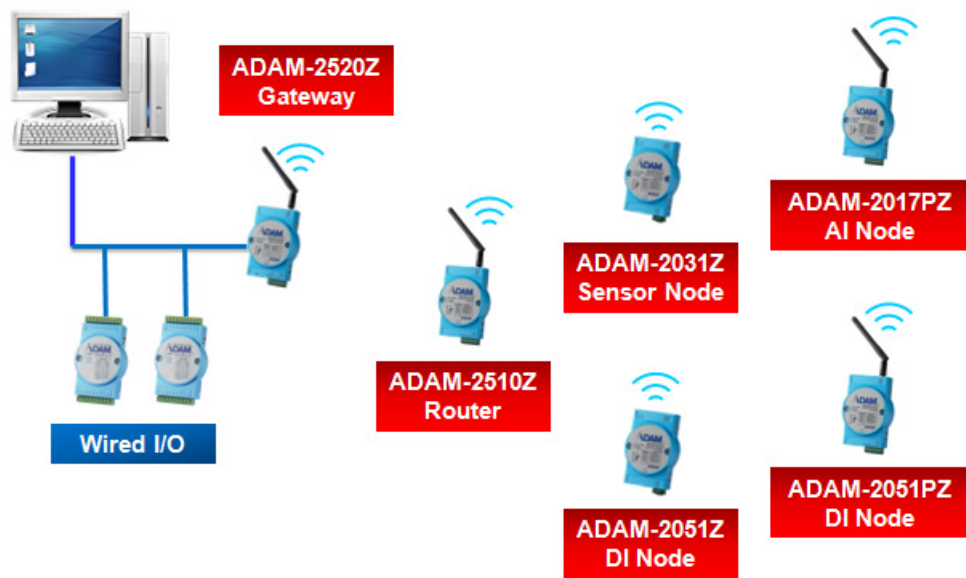

Communication Module	ADAM-2520Z, ADAM-2510Z
I/O Module	ADAM-2017PZ, ADAM-2051Z, ADAM-2051PZ
Sensor Module	ADAM-2031Z

2.1.1 Selecting a Communication Module

Communication modules are fundamental when needing to perform data acquisition and control Wireless Sensor Networks systems. There are two types of communication modules: the coordinator and the router.

A coordinator is essential to associate an Wireless Personal Area Network (WPAN) and as a data collector of the WPAN. Only one coordinator available in a specified WPAN of a specified RF channel. A coordinator also acts as a gateway to translate data packets between two different networks.

The router is optional in a PAN. The major function of a router is to repeat the wireless signal to improve the LQI. With routers, a PAN can be easily extended. More routers in a PAN means larger coverage and capacity of the network.

Table 2.1: Communication Module Selection Guidelines

Choose this communication module: Description

Router	Routers as a wireless signal repeater extends the transmission range and communication quality
Gateway	A gateway collects wireless data from the end node and translate to other communication protocols, such as Modbus RTU.

2.1.2 Selecting an I/O

To organize an ADAM-2000 series remote data acquisition and control system, you need to select proper I/O or sensor modules to connect to field devices or processes that you have previously determined.

Table 2.2: I/O Selection Guidelines

Choose this I/O module:	For these types of field devices or operations (examples):	Description:
Digital Input Node	<ul style="list-style-type: none"> ■ Selector switches Push buttons ■ Photoelectric eyes ■ Limit switches ■ Circuit breakers ■ Proximity switches ■ Level switches ■ Motor starter contacts ■ Relay contacts ■ Thumb wheel switches 	Input modules sense: On/Off signals or Open/Closed signals.
Analog Input Node	<ul style="list-style-type: none"> ■ Thermocouple signals ■ RTD signals ■ Temperature transducers, ■ Pressure transducers ■ Load ■ Cell transducers ■ Humidity transducers ■ Flow transducers, ■ Potential meters 	Convert continuous analog signals into digital input values for host device

2.1.3 Selecting a Sensor Module

Table 2.3: Sensor Mode Selection

Choose this I/O module:	For these types of field devices or operations (examples):	Description:
Sensors Node	<ul style="list-style-type: none"> ■ Temperature measurement ■ Humidity measurement 	Directly measure the physical signal without any conversion.

2.2 Selecting an Operator Interface

To complete your data acquisition and control system, selecting an operator interface is necessary. Adopting the Modbus protocol, ADAM-2000 series I/O modules exhibit high ability in system integration for various applications. For reading the real-time status of ADAM-2000 series modules anywhere without any engineering effort, there is a lot of third-party Modbus software available.

To integrate ADAM-2000 series I/O with HMI, Human Machine Interface, software in a SCADA, Supervisory Control and Data acquisition, system, there are a lot of HMI software packages which support Modbus driver.

- Advantech Studio
- Advantech WebAccess
- Wonderware InTouch
- Intellution Fix of I-Fix
- Any other software which supports the Modbus protocol

Chapter 3

Module Introduction

3.1 Communication Modules

3.1.1 ADAM-2510Z

Wireless Sensor Network Router Node

ADAM-2510Z is a wireless signal repeater / router which is used to extend communication range between the coordinator/gateway and the end device.

3.1.1.1 ADAM-2510Z Specifications

Wireless:

- IEEE Standard: IEEE 802.15.4
- Modulation Type: DSSS (OQPSK)
- Frequency Band: ISM 2.4GHz (2.4 GHz ~ 2.4835 GHz)
- Channels: 11-26
- RF Data Rate: 250 Kbps
- Transmit Power: 19 ± 1 dBm
- Receiver Sensitivity: -97dBm
- Antenna Type: Dipole
- Antenna Gain: 2 dBi
- Outdoor Range: 1000 m (Line of Sight)
- Topology: Star/ Tree/ Mesh
- Function: Router

General:

- Connectors: 1x plug-in terminal block (#14~22 AWG)
- Power Input: Unregulated 10 ~ 30 V_{DC}
- Battery Input: 2 x AA Batteries
- Power Consumption:
 - 0.8 W @ 24 V_{DC}
 - 0.3 W @ 3 V_{DC} (2 x AA Batteries)
- Operating Humidity: 20 ~ 95% RH
- Storage Humidity: 0 ~ 95% RH
- Operating Temperature:
 - External Power -20°C ~ 70°C (-4°F ~ 157.9°F)
 - Battery Power 0°C ~ 50°C (32°F ~ 122°F)
- Storage Temperature: -40°C ~ 85°C (-40°F ~ 185°F)

Note!  ADAM-2510Z router and ADAM-2520Z gateway are always in normal transmission mode during operation, and which power consumption will be higher than other end devices to shorten battery life, therefore, suggest ADAM-2510Z and ADAM-2520Z adopt external power input for main power source and battery power for backup power source.

3.1.2 ADAM-2520Z

Wireless Sensor Network Modbus RTU Gateway

The ADAM-2520Z is designed as a gateway to translate the IEEE 802.15.4 WPAN to Modbus Network. In a WPAN, the ADAM-2520Z works as a coordinator to collect and translate data from end devices to host PC.

3.1.2.1 Specifications

Wireless:

- IEEE Standard: IEEE 802.15.4
- Modulation Type: DSSS (OQPSK)
- Frequency Band: ISM 2.4GHz (2.4 GHz ~ 2.4835 GHz)
- Channels: 11-26
- RF Data Rate: 250 Kbps
- Transmit Power: 19 ± 1 dBm
- Receiver Sensitivity: -97 dBm
- Antenna Type: Dipole
- Antenna Gain: 2 dBi
- Outdoor Range: 1000 m (Line of Sight)
- Topology: Star/ Tree/ Mesh
- Network Capacity: 32 nodes (Routers & End Devices)*
- Range Extenders: Maximum 5 Hops
- Function: Coordinator

*Note: Based on user's configuration

General:

- Connector:
 - 1x plug-in terminal block (#14-22 AWG)
 - 1x USB-type A connector (type A to B cable provide)
- Protocol: Modbus RTU
- Baud Rate: 2400~115200bps
- Power Input: Unregulated $10 \sim 30 V_{DC}$
- Battery Input: 2 x AA Batteries
- Power Consumption:
 - 0.8 W @ $24 V_{DC}$
 - 0.5 W @ $5 V_{DC}$ (USB)
 - 0.3 W @ $3 V_{DC}$ (2 x AA Batteries)
- Operating Humidity: 20 ~ 95% RH
- Storage Humidity: 0 ~ 95% RH
- Operating Temperature:
 - External Power $-20^{\circ}\text{C} \sim 70^{\circ}\text{C}$ ($-4^{\circ}\text{F} \sim 157.9^{\circ}\text{F}$)
 - Battery Power $0^{\circ}\text{C} \sim 50^{\circ}\text{C}$ ($32^{\circ}\text{F} \sim 122^{\circ}\text{F}$)
- Storage Temperature: $-40^{\circ}\text{C} \sim 85^{\circ}\text{C}$ ($-40^{\circ}\text{F} \sim 185^{\circ}\text{F}$)

Note! *ADAM-2510Z router and ADAM-2520Z gateway are always in normal transmission mode during operation, and which power consumption will be higher than other end devices to shorten battery life, therefore, suggest ADAM-2510Z and ADAM-2520Z adopt external power input for main power source and battery power for backup power source.*



3.2 I/O and Sensor Modules

3.2.1 ADAM-2017PZ

Wireless Sensor Network 6-ch Analog Input Node

The ADAM-2017PZ is an analog input data acquisition module with 6 channels to measure the voltage and current.

3.2.1.1 Specifications

Wireless:

- IEEE Standard: IEEE 802.15.4
- Modulation Type: DSSS (OQPSK)
- Frequency Band: ISM 2.4GHz (2.4 GHz ~ 2.4835 GHz)
- Channels: 11-26
- RF Data Rate: 250 Kbps
- Transmit Power: 15 ± 1 dBm
- Receiver Sensitivity: -97 dBm
- Antenna Type: Dipole
- Antenna Gain: 2 dBi
- Outdoor Range: 1000 m (Line of Sight)
- Topology: Star / Tree / Mesh
- Transmission Interval: 1 second ~ 24 hours
- Function: End Device

General:

- Connector: 1x plug-in terminal block (#14-22 AWG)
- Power Input: Unregulated 10 ~ 30 V_{DC}
- Battery Input: 2 x AA Batteries
- Power Consumption: 0.5 W @ 24 VDC/ 16mA
 - 420 uW @ 3 V_{DC} (1 minute Tx interval with 2 x AA Batteries)
 - 240 uW @ 3 V_{DC} (2 minute Tx interval with 2 x AA Batteries)
 - 150 uW @ 3 V_{DC} (5 minute Tx interval with 2 x AA Batteries)
- * Battery Peak Power Consumption: 50mA
- Operating Humidity: 20 ~ 95% RH
- Storage Humidity: 0 ~ 95% RH
- Operating Temperature:
 - External Power -20°C ~ 70°C (-4°F ~ 157.9°F)
 - Battery Power 0°C ~ 50°C (32°F ~ 122°F)
- Storage Temperature: -40°C ~ 85°C (-40°F ~ 185°F)

Note! *ADAM-2017PZ's power consumption will be higher than other end devices to shorten battery life, therefore, suggest ADAM-2017PZ adopt external power input for main power source and battery power for backup power source.*



Analog Input

- Channels: 6 (differential/Non-Isolation)
- Input Impedance: > 10 M Ω (voltage) 120 Ω (current)
- Input Type: mV, V, mA (Configure Different Range for Each Channel)
- Input Max: Voltage: +/-10V
- Common Mode Voltage: Up to 10V_{DC}
- Input Range: ± 150 mV, ± 500 mV, ± 1 V, ± 5 V, ± 10 V, ± 20 mA, 0-20 mA, 4-20 mA
- Accuracy:
 - $\pm 0.1\%$ or Better (voltage) at 25°C
 - $\pm 0.2\%$ or Better (current) at 25°C
- Span Drift: ± 30 ppm/°C
- Zero Drift: ± 22 μ V/°C
- Modbus Data Resolution: 16 bit
- Sampling Rate: 12 sample/second (total)
- CMR @ 50/60 Hz 100 dB
- NMR @ 50/60 Hz 65 dB

3.2.1.2 Connector Pin Define & Switch

Users can configure the switch define by the channel switch for each channel on PCB (refer to the Figure below to see its location):

Switch:

ON: ADAM-2017PZ: Current Input Mode

OFF: ADAM-2017PZ: Voltage Input Mode

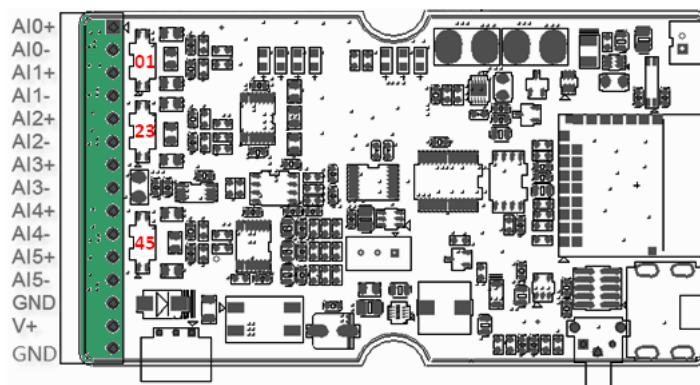

012345: For AI0/1/2/3/4/5 Select Current Input (ON Position)
Voltage Input (OFF Position)

Warning! *When change analog input type please always disconnect the power and analog input from your module whenever you are working on it, do not change switch position while the power is on.*



Warning! *Incorrect analog input configuration may cause device damage. After change analog input switch of channel please change correct input range for each channel through AdamApax .NET utility before you connect analog input signal to the module.*



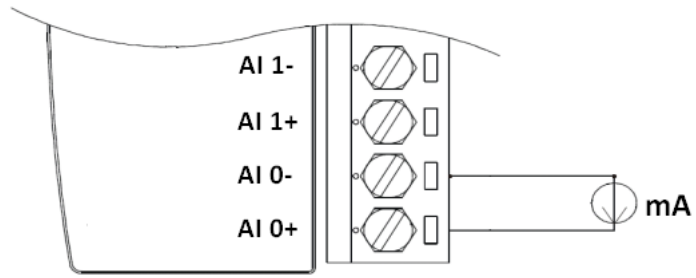

Built-in 120 Ohm Resistor (Current)

Figure 3.1 Current Input Wiring Diagram of ADAM-2017PZ

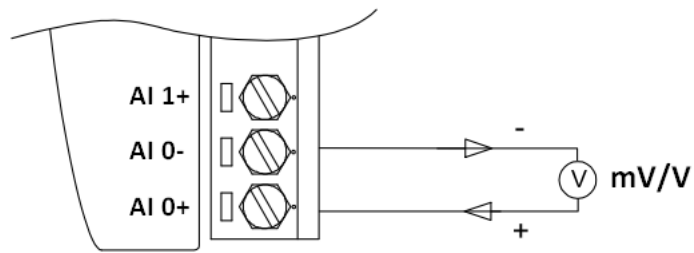

Figure 3.2 Voltage Input Wiring Diagram of ADAM-2017PZ

3.2.2 ADAM-2031Z

Wireless Sensor Network Temperature and Humidity Sensor Node

The ADAM-2031Z is an end device embedded sensors to measure the temperature and humidity physical signal.

3.2.2.1 Specifications

Wireless:

- IEEE Standard: IEEE 802.15.4
- Modulation Type: DSSS (OQPSK)
- Frequency Band: ISM 2.4GHz (2.4 GHz ~ 2.4835 GHz)
- Channels: 11-26
- RF Data Rate: 250 Kbps
- Transmit Power: 3±1 dBm
- Receiver Sensitivity: -97dBm
- Antenna Type: Dipole
- Antenna Gain:0 dBi
- Outdoor Range: 110 m (Line of Sight)
- Transmission Interval: 1 second ~ 24 hours
- Function: End Device

General:

- Connector: 1x plug-in terminal block (#14-22 AWG)
- Power Input: Unregulated 10 ~ 30 V_{DC}
- Battery Input: 2 x AA Batteries
- Power Consumption:
 - 0.3 W @ 24 V_{DC}
 - 420 uW @ 3 V_{DC} (1 minute Tx interval with 2 x AA Batteries)
 - 240 uW @ 3 V_{DC} (2 minute Tx interval with 2 x AA Batteries)
 - 150 uW @ 3 V_{DC} (5 minute Tx interval with 2 x AA Batteries)
- * Battery Peak Current Consumption: 50mA
- * The battery life for 2 x AA 1.5V LR6 Alkaline batteries is 1 year, with 1 minute sampling interval.
- Operating Humidity: 20 ~ 95% RH (non-condensing)
- Storage Humidity: 0 ~ 95% RH
- Operating Temperature: -20°C ~ 70°C (-4°F ~ 157.9°F)
- Storage Temperature: -40°C ~ 85°C (-40°F ~ 185°F)

Temperature Sensor Input

- Operating Range: -20°C ~ 70°C (-4°F ~ 157.9°F)
- Resolution: 0.02°C (0.04°F)
- Accuracy (Battery Mode): ±2.0°C (±1.0°C @ 25 ~ 40°C)
- Repeatability: ±0.1°C (0.4°F)
- Response Rate: ±1°C/min
- Long Term Drift: < 0.04°C/Year (0.07°F/Year)

Humidity Sensor Input

- Operating Range: 20~95% RH
- Resolution: 0.15% RH
- Accuracy (Battery Mode): ±8.0% RH (±6.0% RH @ 40~60% RH)
- Repeatability: ±0.1% RH

-
- Response Time: 8 seconds (Achieving 63% of a step function)
 - Long Term Drift: 0.5% RH/Year

3.2.3 ADAM-2051Z

Wireless Sensor Network 8-ch Digital Input Node

The ADAM-2051Z works as an end device provides 8-ch digital input.

3.2.3.1 ADAM-2051Z Specifications

Wireless:

- IEEE Standard: IEEE 802.15.4
- Modulation Type: DSSS (OQPSK)
- Frequency Band: ISM 2.4GHz (2.4 GHz ~ 2.4835 GHz)
- Channels: 11-26
- RF Data Rate: 250 Kbps
- Transmit Power: 3 ± 1 dBm
- Receiver Sensitivity: -97 dBm
- Antenna Type: Dipole
- Antenna Gain: 2 dBi
- Outdoor Range: 110 m (Line of Sight)
- Topology: Star / Tree / Mesh
- Transmission Interval: 1 second ~ 24 hours
- Function: End Device

General:

- Connector: 1x plug-in terminal block (#14-22 AWG)
- Power Input: Unregulated 10 ~ 30 V_{DC}
- Battery Input: 2 x AA Batteries
- Power Consumption:
 - 0.3 W @ 24 V_{DC}
 - 380 uW @ 3 V_{DC} (1 minute Tx interval with 2 x AA Batteries)
 - 220 uW @ 3 V_{DC} (2 minute Tx interval with 2 x AA Batteries)
 - 130 uW @ 3 V_{DC} (5 minute Tx interval with 2 x AA Batteries)
- * Battery Peak Current Consumption: 50mA
- * The battery life for 2 x AA 1.5V LR6 Alkaline batteries is 1 year, with 1 minute sampling interval.
- Operating Humidity: 20 ~ 95% RH
- Storage Humidity: 0 ~ 95% RH
- Operating Temperature: -20°C ~ 70°C (-4°F ~ 157.9°F)
- Storage Temperature: -40°C ~ 85°C (-40°F ~ 185°F)

Digital Input:

- Channels: 8
- Input Resistance: 10 KOhm
Supports wet and dry contacts
- Input Level:
 - Logical level 0: 0 ~ 0.8 V_{max}
 - Logical level 1: 2.0 V_{min} ~ 5.0 V_{max}

3.2.4 ADAM-2051PZ

Wireless Sensor Network 8-ch Digital Input Node with Power Amplifier

The ADAM-2051PZ works as an end device provides 8-ch digital input with wireless power amplifier for better transmission power and receive sensitivity to enhance communication range and quality.

3.2.4.1 ADAM-2051PZ Specifications

Wireless:

- IEEE Standard: IEEE 802.15.4
- Modulation Type: DSSS (OQPSK)
- Frequency Band: ISM 2.4GHz (2.4 GHz ~ 2.4835 GHz)
- Channels: 11-26
- RF Data Rate: 250 Kbps
- Transmit Power: 19 ±1 dBm
- Receiver Sensitivity: -97 dBm
- Antenna Type: Dipole
- Antenna Gain: 2 dBi
- Outdoor Range: 1000 m (Line of Sight)
- Topology: Star / Tree / Mesh
- Transmission Interval: 1 second ~ 24 hours
- Function: End Device

General:

- Connectors: 1x Plug-in terminal block (#14-22 AWG)
- Power Input: Unregulated 10 ~ 30 V_{DC}
- Battery Input: 2 x AA Batteries
- Power Consumption:
 - 0.3 W @ 24 V_{DC}
 - 380 uW @ 3 V_{DC} (1 minute Tx interval with 2 x AA Batteries)
 - 220 uW @ 3 V_{DC} (2 minute Tx interval with 2 x AA Batteries)
 - 130 uW @ 3 V_{DC} (5 minute Tx interval with 2 x AA Batteries)
- * Battery Peak Current Consumption: 60mA
- * The battery life for 2 x AA 1.5V LR6 Alkaline batteries is 1 year, with 1 minute sampling interval.
- Operating Humidity: 20 ~ 95% RH
- Storage Humidity: 0 ~ 95% RH
- Operating Temperature: -20°C ~ 70°C (-4°F ~ 157.9°F)
- Storage Temperature: -40°C ~ 85°C (-40°F ~ 185°F)

Digital Input:

- Channels: 8
- Input Resistance: 10 KOhm
Supports wet and dry contacts
- Input Level:
 - Logical level 0: 0 ~ 0.8 V_{max}
 - Logical level 1: 2.0 V_{min} ~ 5.0 V_{max}

Application Wiring:

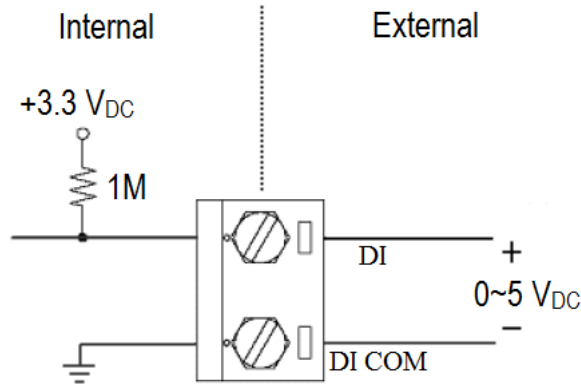

Figure 3.3 ADAM-2051Z/2051PZ Wet Contact Diagram

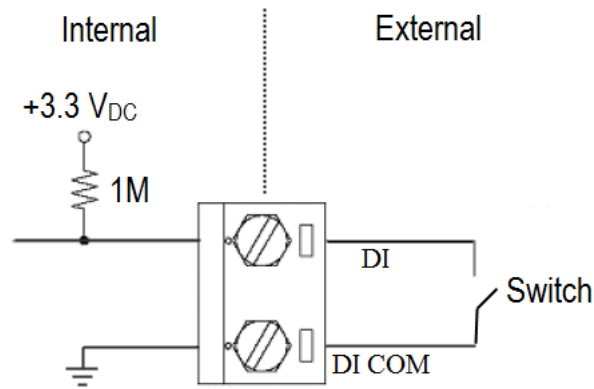

Figure 3.4 ADAM-2051Z/2051PZ Dry Contact Diagram

Chapter 4

Installation Guide

4.1 Determining the Proper Environment

Prior to installing ADAM-2000 series modules, please check the following.

4.1.1 Package Contents

Unpack the package and make sure that the contents include:

- ADAM-2000 series module
- 2 dBi antenna (ADAM-2520Z, ADAM-2510Z, ADAM-2017PZ, and ADAM-2051PZ)
- 2 x Mounting kits
- ADAM-2000 series CD (User manual, datasheet, Quick start guide and AdamA-pax .NET Utility)

4.1.2 System Requirements

- IBM PC compatible computer with at least 486 CPU (Pentium recommended)
- Microsoft Windows 2000, XP, Vista and 7 (32/64Bit)
- At least 32 MB RAM
- 20 MB of hard disk space available
- VGA color monitor
- CD-ROM or DVD-ROM
- Mouse or other pointing devices
- Power Supply for ADAM-2000 Series (+10 ~ +30 V_{DC} Unregulated) or 2 AA batteries

4.1.3 Perform a Wireless Sensor Network

Coordinator, Router and End Device are three basic elements of the Wireless Sensor Network. Each of them has different functions. All the nodes have to set the same PAN ID and RF channel to perform the communication.

A Coordinator is essential to associate a PAN of the Wireless Sensor Network in a specific PAN ID and RF channel. It is also a data collector of the PAN and usually works as a gateway to translate wireless data into any other data formats, such as Modbus RTU.

A router is optional in a PAN. It works as a wireless repeater to enhance the wireless signal strength and selects the optimistic path for a end node to route data back to the coordinator. A PAN with routers can make the network work as tree or mesh topology.

An End Device (End Node) is the basic element to acquire the physical signals and data from I/O, sensor and even communication interface. It can be designed for many different functions and is possible for standalone applications by battery-power.



Figure 4.1 The Architecture of the Wireless Sensor Network

4.2 Establish the Connection

4.2.1 Basic Installation

In the side of the ADAM-2000 series, users can find **Mode Switch** and **Function Button**. The two hardware keys contain several combinations for device operations. The default position of **Mode Switch** is set in the Initial Mode to configure the device and establish connection for Normal Mode.

It is easily to use the ADAM-2000 series with default configuration. Push the **Mode Switch** on the side of ADAM-2000 devices to **Normal** position then the PAN can be operated to collect data from modules. The ADAM-2000 series also provides advanced functions for further operations.

Initial Mode

The Initial Mode is for user to configure parameters of the ADAM-2000 devices. While the device is in the **Initial Mode**, Status LED turns on.

1. Push the **Mode Switch** to the **Initial** position.
2. Open the AdamApax .NET Utility to search and configure the ADAM-2000 devices.

Normal Mode

After all the ADAM-2000 devices are configured in the same PAN ID and RF channel, push the **Mode Switch** to **Normal** position to perform the Wireless Sensor Network.

Connection Steps in Initial Mode:





4.2.1.1 Coordinator

1. Power on.
2. All LEDs turn on for 0.5 second then turn off.
3. Status LED turns on, Error LED blinks.
4. **Level Index** turns on to indicate Pair ID 1. (Pair ID will automatically count if there is a coordinator nearby).
5. Error LED turns off when it hosts a PAN.



4.2.1.2 Router/End Device

Routers and End Devices must have to associate with corresponding Pair ID Coordinator in **Initial Mode** to build up the wireless communication. The function is for Router and End Devices only.

1. Power on.
2. All LEDs turn on for 0.5 second then turn off.
3. Press the  **Function Button** 3 times to join a PAN with the default Pair ID 1.
4. Status LED turns on, Error LED blinks.
5.  **Level Index** turns on to indicate Pair ID 1. (Pair ID needs to be properly configured if there are coordinators. For advanced settings, please refer to section 4.3)
6. If the Coordinator Pair ID is not 1, hold the **Function Button** for 2 seconds to reboot your router or end-devices, then press **Function Button** 5 times to enter Pair ID selection, the click N times according the Coordinator Pair ID, then hold the **Function Button** for 2 seconds to confirm your setting, finally press the **Function Button** 3 times to join a PAN.
7. Error LED turns off when it join a PAN.





Once the Coordinator, Routers and End Devices are connected in the same Pair ID then all devices can be configured through AdamApax .NET Utility for Normal Mode operation. (For detailed operation and functionality of AdamApax .NET Utility, please refer to Chapter 5.) Push the  **Mode Switch** to the **Normal** position to reboot the device to Normal Mode.

Note! To set up the Coordinator, Routers and End Devices, make sure they are in the same mode, otherwise they can't be configured.



4.2.1.3 Router and End Device Connection Network limitation

When we adopt a large number of ADAM-2000 devices in one application architecture, which may cause low network performance or data package transmission collision. Assume ADAM-2520Z like a funnel which receives data around routers and end devices, if setting too fast transmission interval that will generate high data package transmission collision during the transmission then affect network performance and data receiving.

The images below comparisons between Multi-End Device performance and the relationship between Multi-End Devices and Routers. Their purpose is to assist the user in installing the ADAM-2000 devices in a proper network configuration and operation.

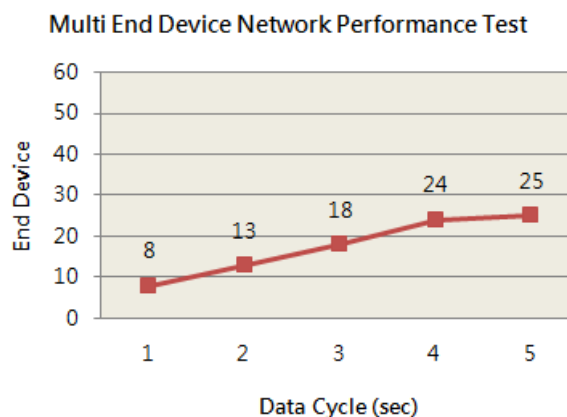

Figure 4.2 Multi-End Device Network performance

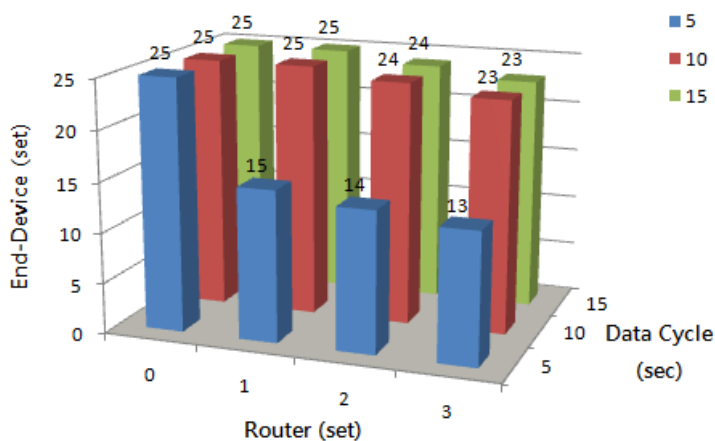

Figure 4.3 Multi-End Device and Router Network Relationship

4.2.2 ADAM-2000 Series Installation Flowcharts

The following flowcharts are designed to tell you how to install the ADAM-2000 models.

4.2.2.1 ADAM-2000 Series Installation Overview

The section describes how to host a WPAN for the ADAM-2000 series. The coordinator, end devices are basic component for the wireless data acquisition system. Routers are optional to enhance the network coverage and mesh mechanism. Please refer to the following flowchart for the overview of the ADAM-2000 installation, configuration and operation.

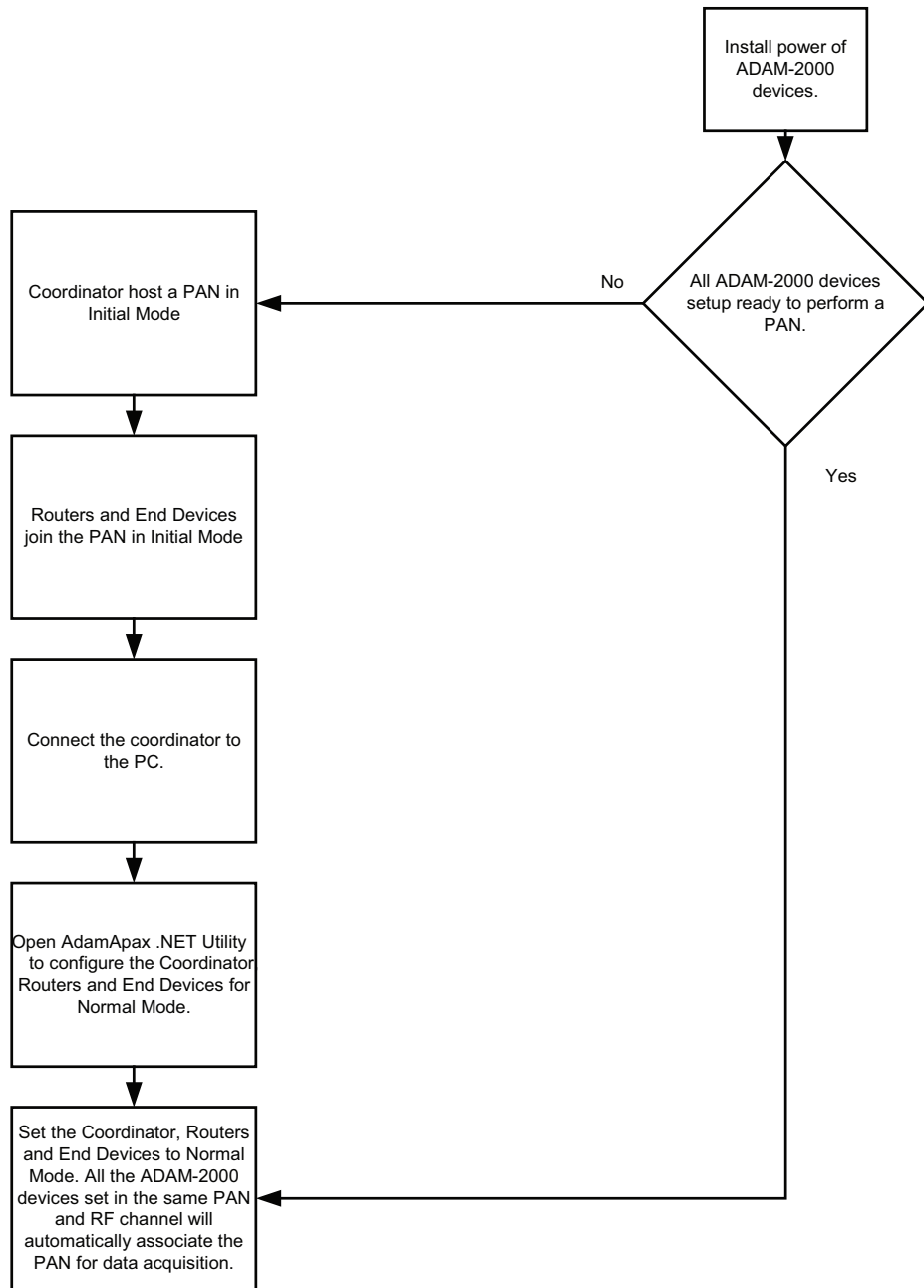
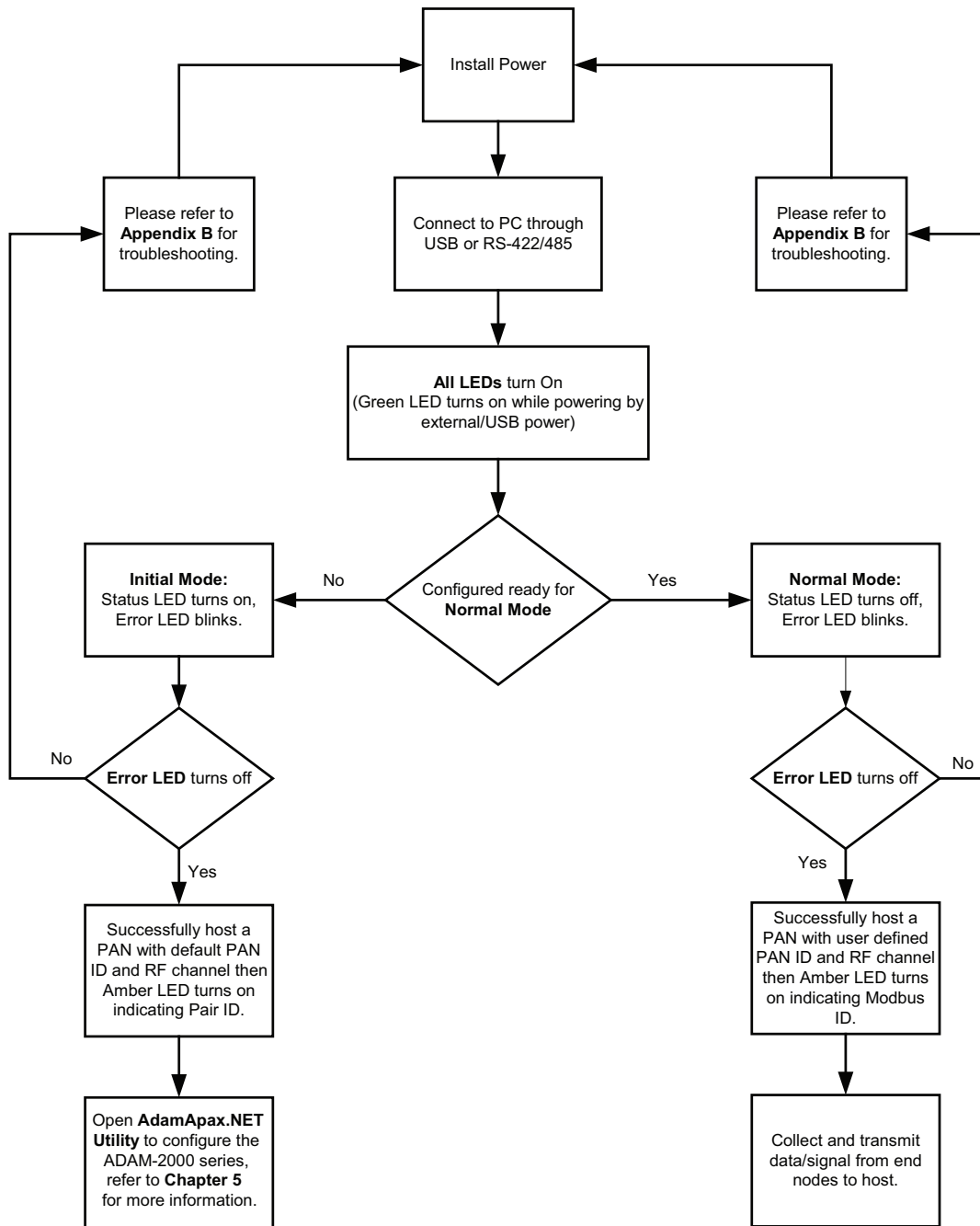

Figure 4.4 ADAM-2000 Installation Chart

4.2.2.2 Coordinator Configuration Flowchart

The section tells the user how to setup the Coordinator to host a PAN for a wireless sensor network.



4.2.2.3 Router Configuration Flowchart

The section tells the user how to setup the Router to enhance the wireless communication range and coverage of a PAN for a wireless sensor network.

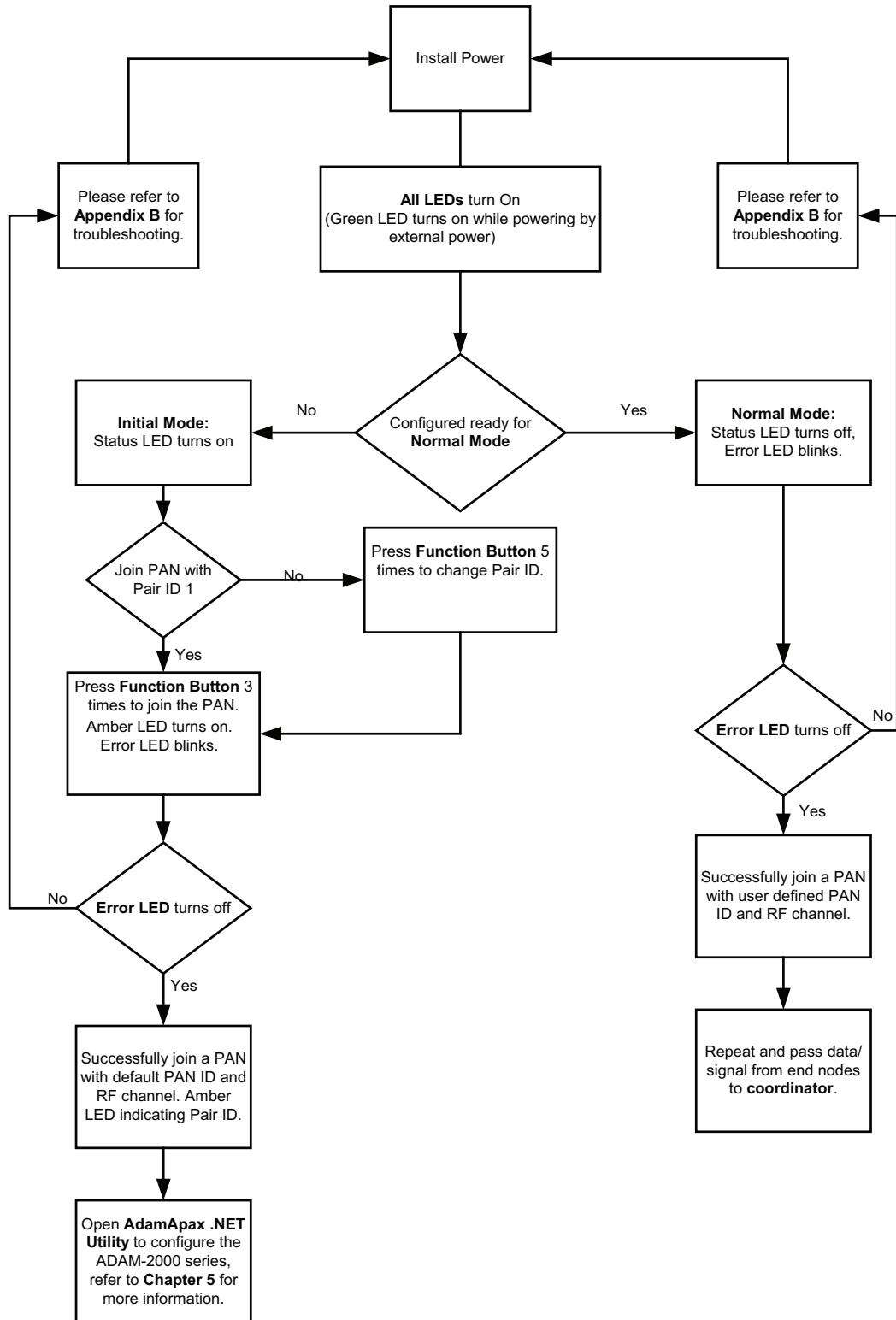

4.2.2.4 End Device Configuration Flowchart

The section tells the user how to setup the End Devices to do data acquisition of a PAN for a wireless sensor network.

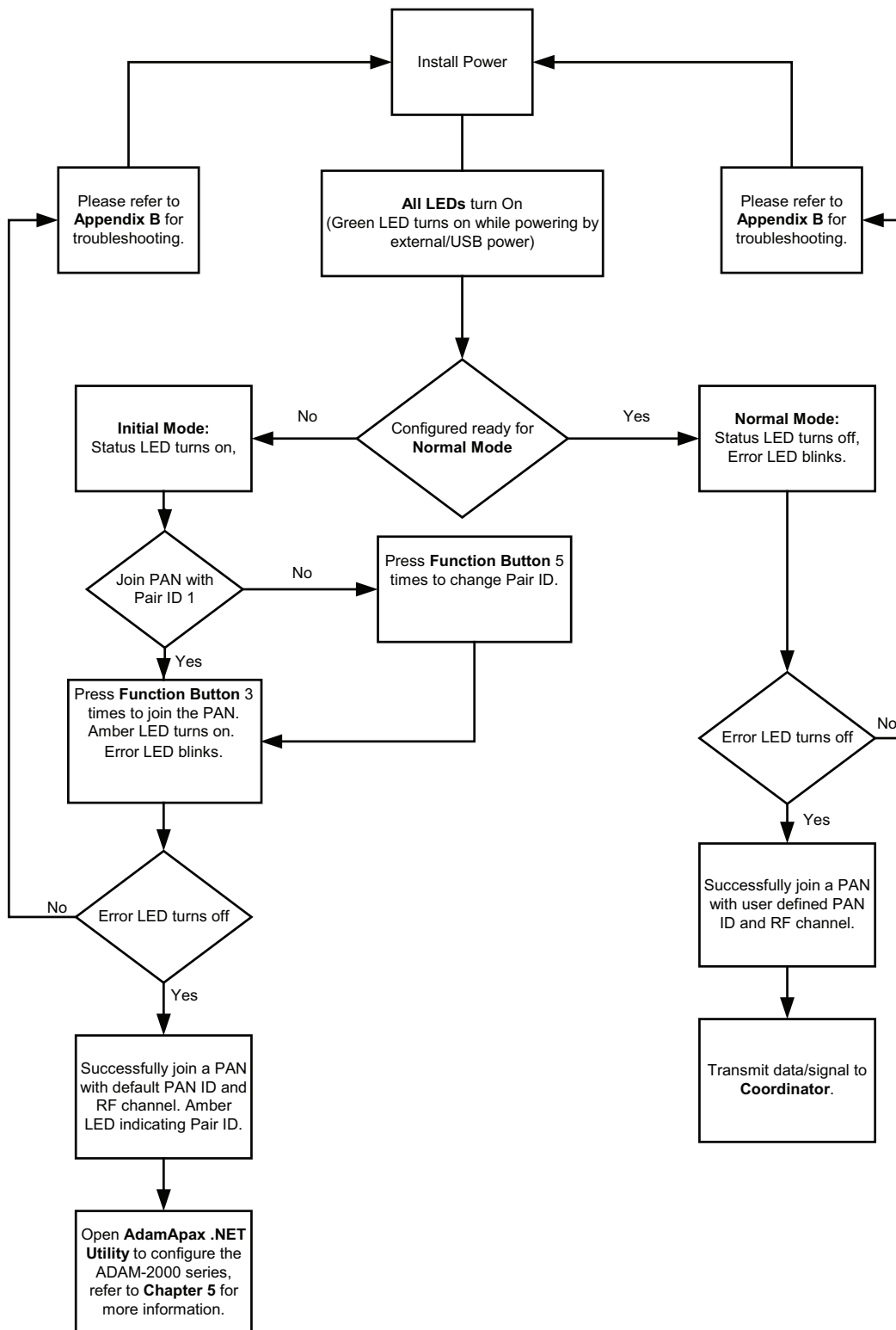

4.3 Advanced Functions

4.3.1 Link Quality Indicator

The LQI represents the wireless signal index and can assist the user to install the ADAM-2000 devices in proper location for good communication quality. The LQI function is only available for Router and End Devices. Press the **Function Button** once and the Level Index in the front panel will turn on to indicate the level of LQI.

Table 4.1: Level of LQI

Level Index Conditions	Description
3 LED ON, 1 LED Blink	Excellent
2 LED ON, 1 LED Blink	Good
1 LED ON, 1 LED Blink	Normal
1 LED Blink	Poor
No LED on, Error LED blinks	No Signal

4.3.2 Battery Level

All ADAM-2000 devices are all designed to be used with batteries. Users can install 2 AA batteries for extended operation or back-up power. Press the **Function Button** twice and the Level Index in the front panel will turn on to indicate the level of battery power.

Table 4.2: Level of battery power

Level Index Conditions	Description	Percentage of Battery
3 LED ON, 1 LED Blink	Excellent	100%~ 81%
2 LED ON, 1 LED Blink	Good	80%~ 61%
1 LED ON, 1 LED Blink	Normal	60%~ 41%
1 LED Blink	Poor	40%~ 21%
No LED on, Error LED blinks	Low battery	Below 21%

4.3.3 Pairing

In the **Initial Mode**, Routers and End Devices must be associated with the corresponding Coordinator. The function is for Router and End Devices only.

1. Press the **Function Button** 5 times to enter the change Pair ID mode.
2. Status LED blinks
3. Level Index LED turns on to indicate Pair ID.
4. Press the **Function Button** once to change Pair ID.
5. Press and hold the **Function Button** for over 2 seconds to save and confirm the Pair ID.
6. Press the **Function Button** 3 times to associate with specific Pair ID Coordinator.
7. Error LED turns off when it join a PAN.

4.3.4 Associating Devices

Routers and End Devices must have to associate with corresponding Pair ID Coordinator in **Initial Mode** to build up the wireless communication. The function is for Router and End Devices only.

1. Press the **Function Button** 3 times to join a PAN with specific Pair ID Coordinator.
2. Status LED turns on, Error LED blinks.
3. Level LED turns on to indicate the Pair ID to associate with.
4. Error LED turns off when it joins a PAN.

4.3.5 Reboot

Press the **Function Button** for over 3 seconds to reboot the device.

4.3.6 Button Function Table

Table 4.3: Button Functions	
Press Button	Function
2 Seconds	Confirm the Pair ID
3 Seconds	Reboot
Once	Link Quality Indicator
2 Times	Battery Level
3 Times	Network Association
5 Times	Pair ID Selection

4.4 Conduct a Site Survey

Performing a Site Survey before installing the WSN is a necessary procedure to ensure reliable communication. The following description demonstrates the standard process of Site Survey.

4.4.1 Before Going Onsite

1. Ask the customer for the maps and collect the information in previous chapter the more the merrier.
2. Check with the customer for the possible position to install the coordinator.
3. Setup all modules
 - Prepare the following items:
 - ADAM-2520Z *1
 - ADAM-2510Z *8, it depends on the area of site, 8 router can organize two 5-hop network
 - ADAM-2051PZ *1
 - 2 AA batteries for the above modules
 - Set all modules in same PAN ID and RF Channel. The RF Channel suggests to be set to channel 15 or 20 to avoid the interference of WLAN.
 - Set all modules' data cycle to 5 second.
 - Set all modules as individual ID address.
 - Install batteries for all modules.
 - Switch all modules to normal mode and use utility to check all modules are work.
 - Switch all modules to initial mode and remove the batteries.

4.4.2 Onsite Survey

1. Setup Coordinator
 - When arriving the site, power up ADAM-2520Z with batteries and switch it to normal mode.
 - Install ADAM-2520Z at the place that can be seen from most of the place or corner to ensure the signal can be easier to be accessed.
 - If possible, do not install on the concrete wall, heavy column, or girder.
 - The antenna should be vertical to the plane that going to install other modules.
2. Add Router
 - Install batteries to one of the ADAM-2051PZ, and switch it to normal mode.
 - Press the button of ADAM-2051PZ one time to check the link quality
 - Walk away from coordinator and keep checking the LQI until only one LED level is on.
 - Add one router with batteries and work in normal mode at that position
 - Check the LQI of router 5 times to make sure a least one LED level is on.
 - Check the ADAM-2051PZ has full LED level at the same place, if only one LED level is on, switch it to initial mode and then back to normal mode to re-register the routing.
 - Walk away from the new added router and use the same way to add next router until the position of end-devices that will install can access the network.

Chapter 5

Software
Configuration Guide

5.1 System Software Configuration Utility

The AdamApax .NET Utility software offers a graphical interface that helps you configure the ADAM-2000 series. It is also very convenient to test and monitor your remote data acquisition and control system. The following guidelines will give you some brief instructions on how to use this Utility. Before installing the ADAM.NET Utility, remember to first install .NET Framework 2.0 or later from Microsoft website.

5.2 Installing AdamApax .NET Utility Software

Caution! 1. Make sure both coordination and devices are in **Initial Mode**



2. Ensure that you are using a minimum of Windows 2000, XP or Windows 7
3. Before installing ADAM.NET Utility, you need to install the .NET Framework 2.0 or later.

Advantech provides a free download of AdamApax .NET Utility software for module operation and configuration. You can find the Utility installation file in the CD with your module, or on our website at: <http://www.advantech.com> and click the Download Area under Service & Support to get the latest version of the ADAM.NET Utility. Once you download and setup the Utility software, there will be a shortcut of the Utility program on the desktop.

5.3 AdamApax .NET Utility Operation

After you have successfully installed AdamApax.NET Utility, there will be one shortcut icon on the desktop. Double click the shortcut icon that you should be able to see the operation window.

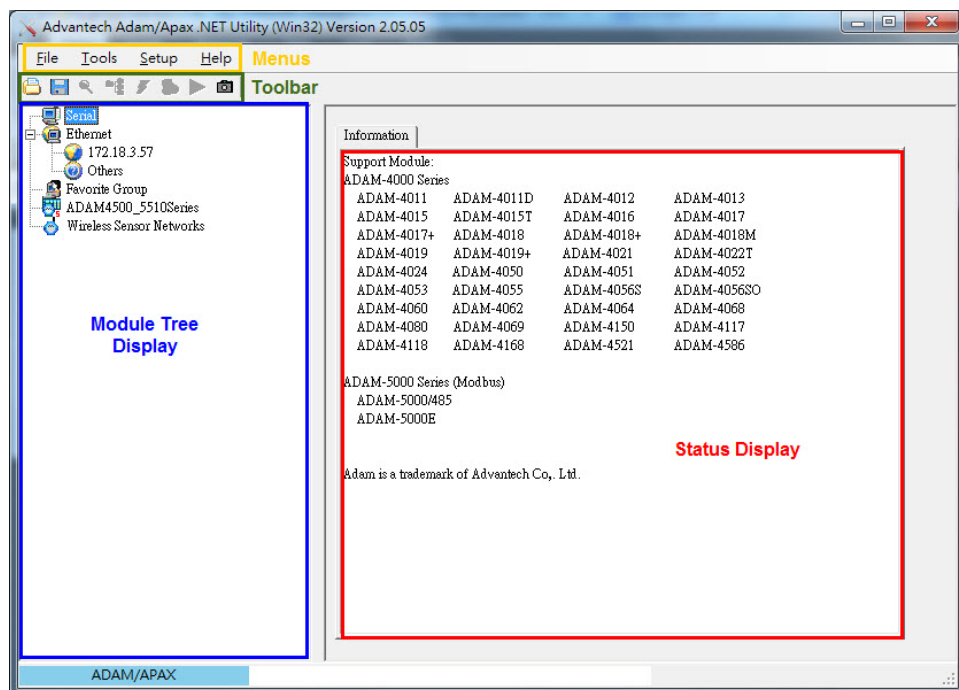

Figure 5.1 AdamApax .NET Utility Operation Window

The operation window consists of four areas --- the **Menus**, the **Toolbar**, the **Module Tree Display Area** and the **Status Display Area**.

Menus

The menus at the top of the operation window contain:

File Menu:

1. Open Favorite Group - You can configure your favorite group and save the configuration into one file. Using this option, you can load your configuration file for favorite group.
2. Save Favorite Group - You can configure your favorite group and save the configuration into one file. Using this option, you can save your favorite group into one configuration file.
3. Auto-Initial Group - If you want to have the same favorite group configuration when you exit AdamApax .NET Utility and launch it again, you need to check this option.
4. Exit - Exit AdamApax.NET Utility.

Tools Menu:

1. Search- Search all the ADAM-2000, ADAM-4000, ADAM-5000 and ADAM-6000 modules you connected.
2. Add Devices to Group - You can add ADAM modules to your favorite group by this option. You need to select the device you want to add in the **Module Tree Display** area (it will be described below) first, and then select this option to add.
3. Print Screen - You can save current AdamApax .NET Utility screen into an image file by this option.

Setup Menu:

1. Favorite Group - You can configure your favorite group including add one new device, modify or delete one current device, sort current devices and diagnose connection to one device.
2. Refresh COM and LAN node - AdamApax .NET Utility will refresh the serial and LAN network connection situation.
3. Add COM Port Tree Nodes - This option is used to add serial COM ports in AdamApax.NET Utility.
4. Show TreeView - Check this option to display the **Module Tree Display** area.

Help Menu:

1. Check Up-to-Date on the Web - Choose this option, it will automatically connect to Advantech download website. You can download the latest utility there.
2. About AdamApax .NET Utility- Choose this option, you can see version of AdamApax .NET Utility installed on your computer.

Note! The **Favorite Group** function is for the ADAM-4000, ADAM-5000/TCP and ADAM-6000



Toolbar

There are 8 graphical icons on the toolbar for 8 common used options of Menu. Figure 5.2 below shows definition for each graphical icon.

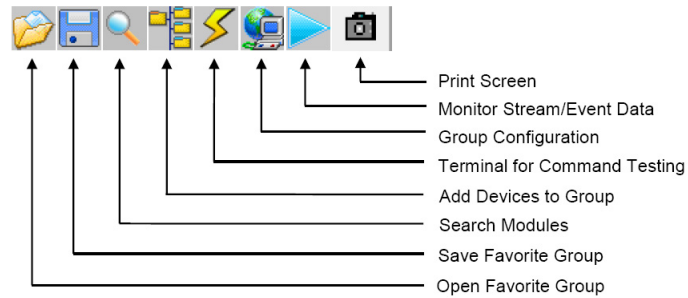

Figure 5.2 AdamApax .NET Utility Toolbar

Module Tree Display Area

AdamApax .NET Utility is one complete software tool that all ADAM remote I/O module and controller can be configured and operated in this utility. The **Module Tree Display** is on the left part of the utility operation window. There are five categories in the **Module Tree Display** Area:

- **Serial**
All serial I/O Modules (ADAM-4000 and ADAM-5000 RS-485 serial modules) connected to the host PC will be listed in this category.
- **Ethernet**
All Ethernet I/O Modules (ADAM-6000 and ADAM-5000 TCP modules) connected to the host PC will be listed in this category.
- **ADAM-4500_5510 Series**
This is a DOS interface utility for remote controllers such as ADAM-4500 and ADAM-5510 series.
- **Favorite Group**
You can define which devices listed in the three categories above into your personal favorite group. This will make you easier to find your interested modules. Right click on the ADAM device item under the Favorite Group item and you can select **New >> Group** to create a new group. After you create your own group, right click on your group and select **New >> Adam device** to add ADAM devices into your group. You can also select **Diagnose connection** to check the communication.
- **Wireless Sensor Networks**
The category contains the ADAM-2000 series. You can connect the ADAM-2000 series, through the serial interface. The ADAM-2000 series will be listed for further configuration.

Status Display Area

Status Display area, on the right part of utility operation window, is the main screen for operation. When you select different items in **Module Tree Display**, **Status Display** will change dependently. You can do all configurations and test in this area.

5.3.1 USB Driver Installation

If the user wants to use USB cable to connection with AdamApax .NET Utility on PC, they need to install USB chip driver in CD.

Step 1

Connect a USB cable between the ADAM-2520Z and the PC, and the system will pop out message to install new device, find the USB folder to select USB chip driver in out CD.

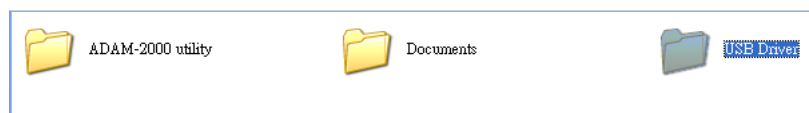

Base on your PC for 32 bit or 64 bit to select your suitable USB chip driver, then PC will auto install. After install finished, you can see which port your system get in device manager like bellow one. (Note: base on your system, this picture just for sample)

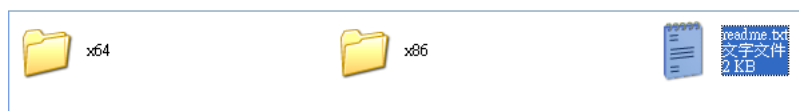

Then restart the AdamApax .NET Utility.

5.3.2 Search and Configure the ADAM-2000 Series

The ADAM-2000 series can be searched and configured through AdamApax .NET Utility. Make sure the ADAM-2000 devices are installed properly in Initial Mode. For more information, please refer to the Chapter 4.2.

The supported Wireless Sensor Networks Modules are listed in the information page.

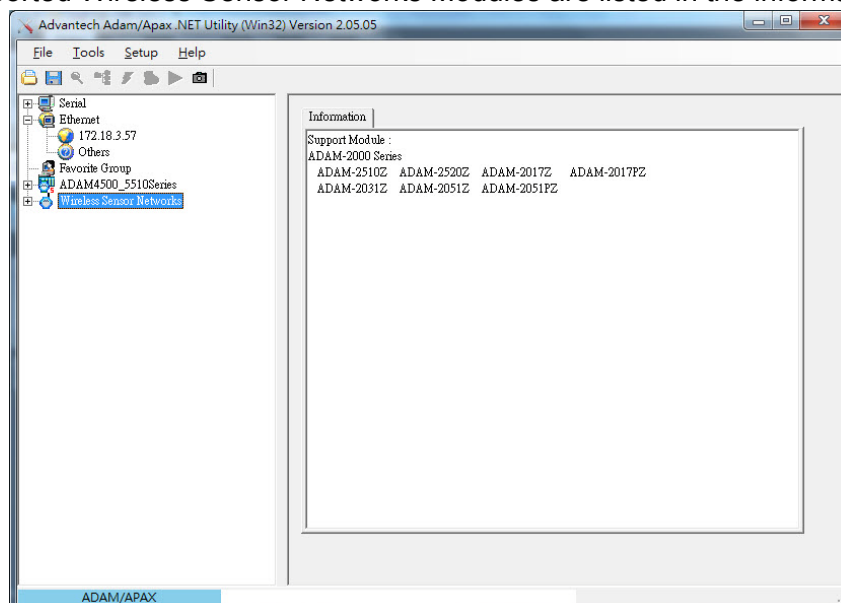

Figure 5.3 ADAM-2000 Series AdamApax .NET Utility Support

Click the “Serial” in the Wireless Sensor Networks category then click right button to select the “Refresh Subnode” to search the virtual COM port on the host PC.

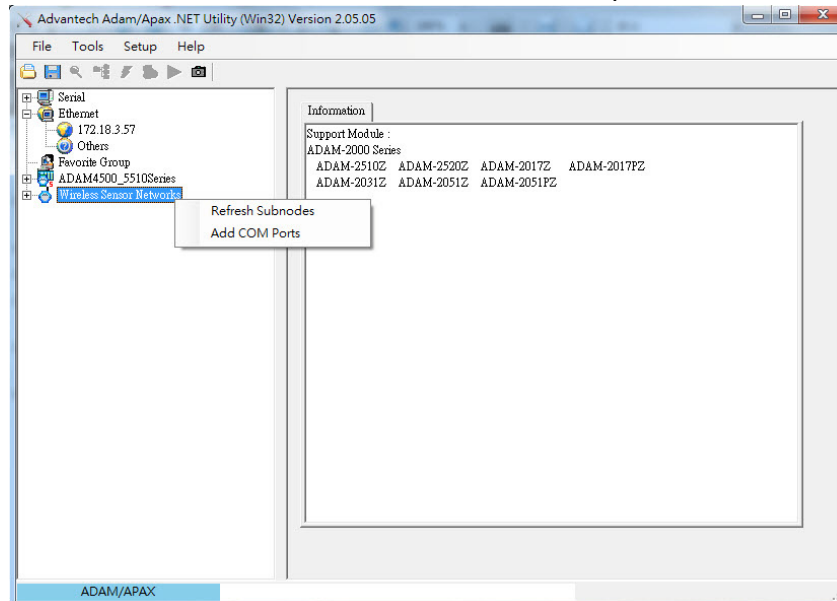

Figure 5.4 Search the USB interface ADAM-2000 devices on the host PC for the virtual COM port.

Click the COM port then click right button to select the "Search" to find the ADAM-2000 devices.

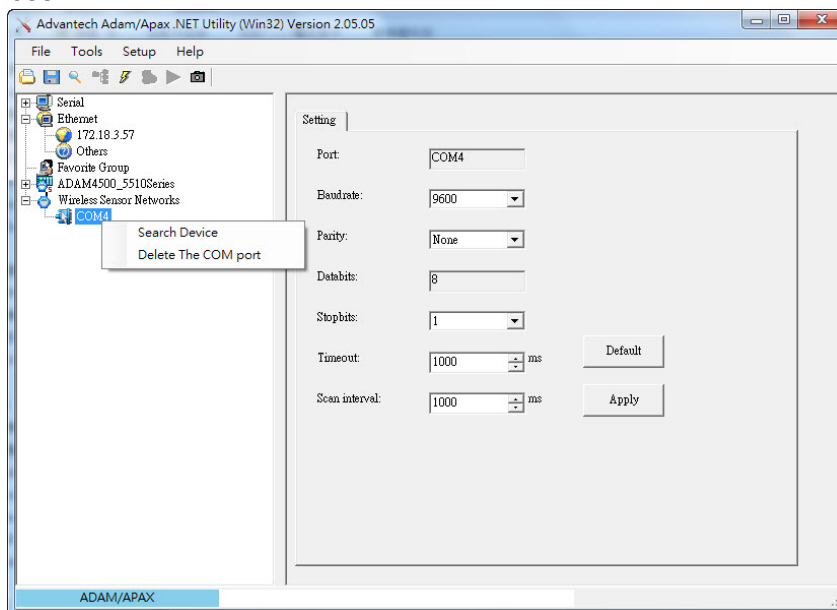

Figure 5.5 Search the COM port for the ADAM-2000 devices.

The “Searching the network” dialog will pop up, click “Start” to search the ADAM-2000 devices. The AdamApax .NET Utility search the ADAM-2000 Coordinators from Initial mode Modbus ID 241(F1h)-244(F4h) [for Normal mode Modbus ID 245(F5h)-248(F8h)], refer to Appendix A.2 for more information.

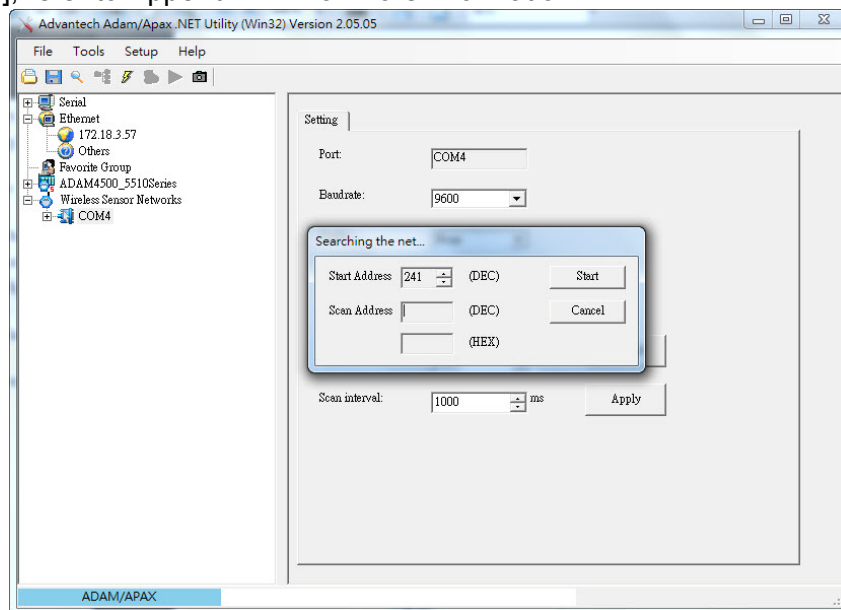

Figure 5.6 Searching the network dialog

The ADAM-2000 coordinators will be listed on the Tree View of the selected COM port.

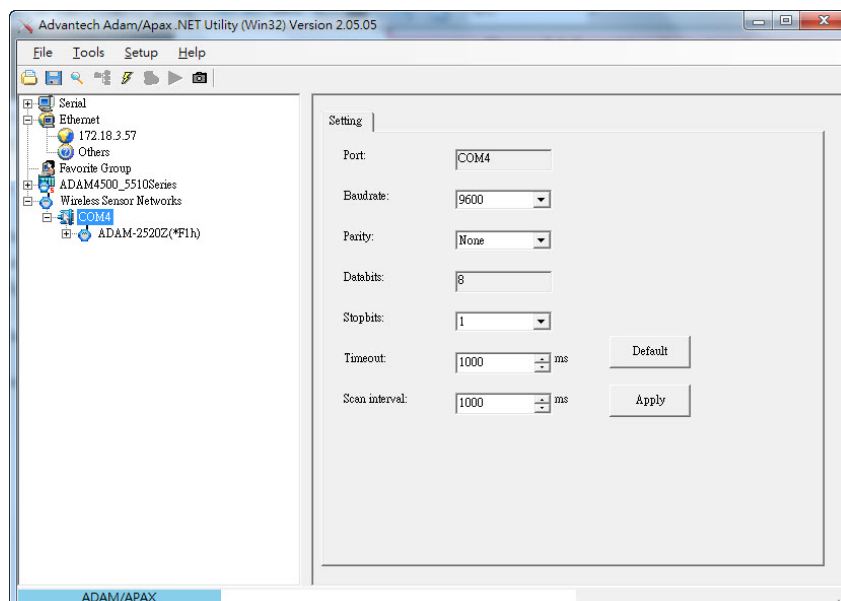

Figure 5.7 Searching the ADAM-2000 coordinators.

If you also want to connect ADAM-2000 series to utility at the same time,

1. Make sure they are in initial mode
2. Set PAN ID in the same group

Bellow picture is router or end-device signal label for you reference, it also list on ADAM-2000 series part.

Press Button	Function
2 seconds	Reboot / Confirm
1 time	Link Quality Indicator
2 times	Battery Level
3 times	Associate
5 times	Pair ID

Note! ADAM-2520Z each time you turn to initial mode, beware its Pair ID would be changed because system will depend on your wireless environment to get Pair ID to avoid ID conflict. So must make sure your device using same Pair ID and in same group.



While the searching is done, the ADAM-2000 devices will be listed on the Tree View with information and parameter pages. The ADAM-Router folder lists routers under the coordinator (Gateway). The ADAM-End Device folder lists end devices also under the coordinator (Gateway).

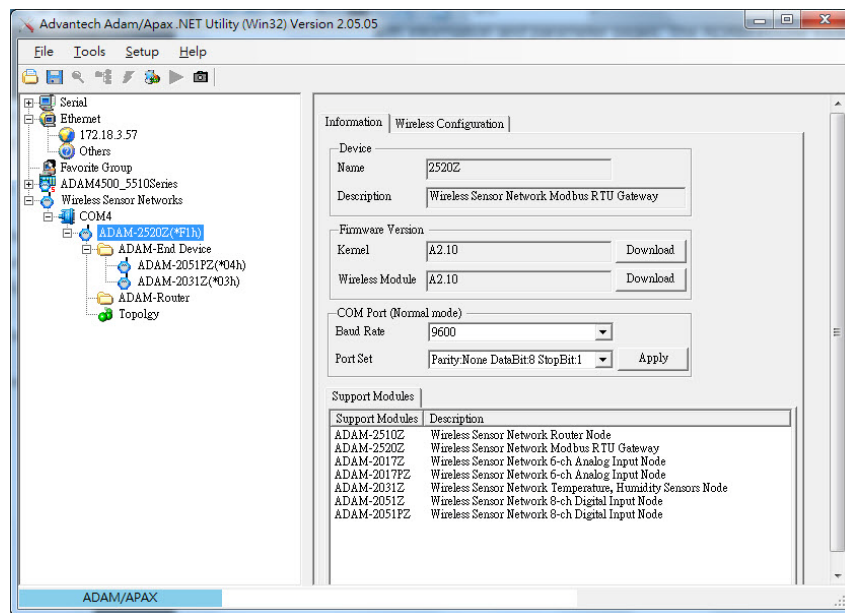

Figure 5.8 ADAM-2000 devices lists on the Tree View and Information page.

Note! When End Device and Router are set in same slave ID that modules tree view will be highlighted in yellow.



Folder of ADAM-End Device lists the ADAM-2000 end devices in Tree View and List View of End Device page. The page contains an overview of the end devices and the status.

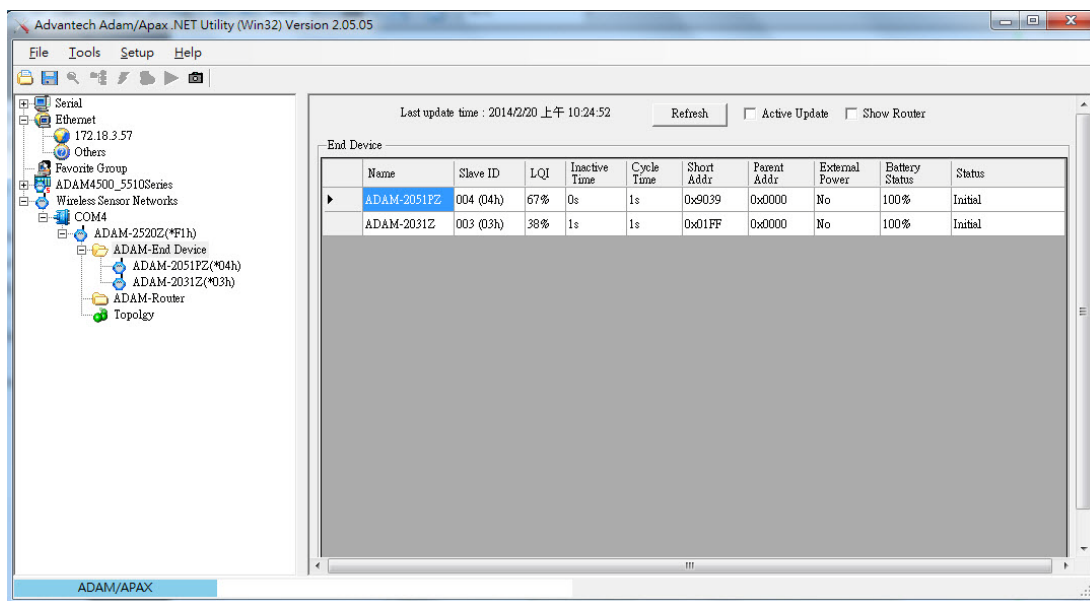

Figure 5.9 The overview of ADAM-2000 end devices.

Folder of ADAM-Router lists the ADAM-2000 routers in Tree View and List View of Router page. The page contains an overview of the routers and the status.

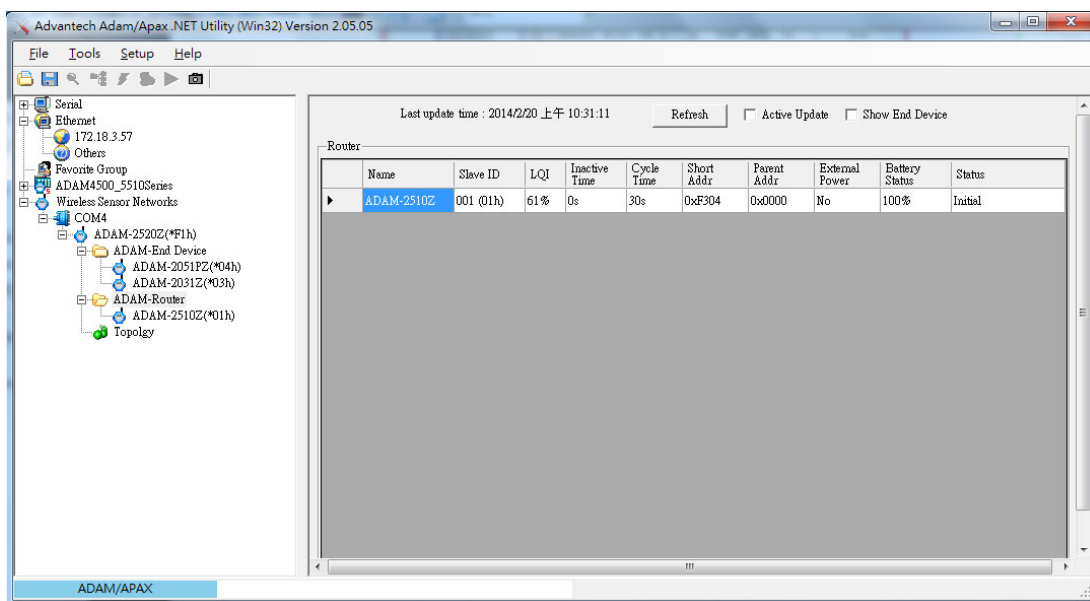

Figure 5.10 The overview of ADAM-2000 routers

5.3.2.1 Gateway - ADAM-2520Z

Click the ADAM-2520Z, it will display the Information and Wireless Configuration pages.

In the Information page:

1. User can download the firmware to the ADAM-2520Z if there is any upgrade firmware from the Advantech.
2. User can modify the COM port parameters for **Normal Mode**.

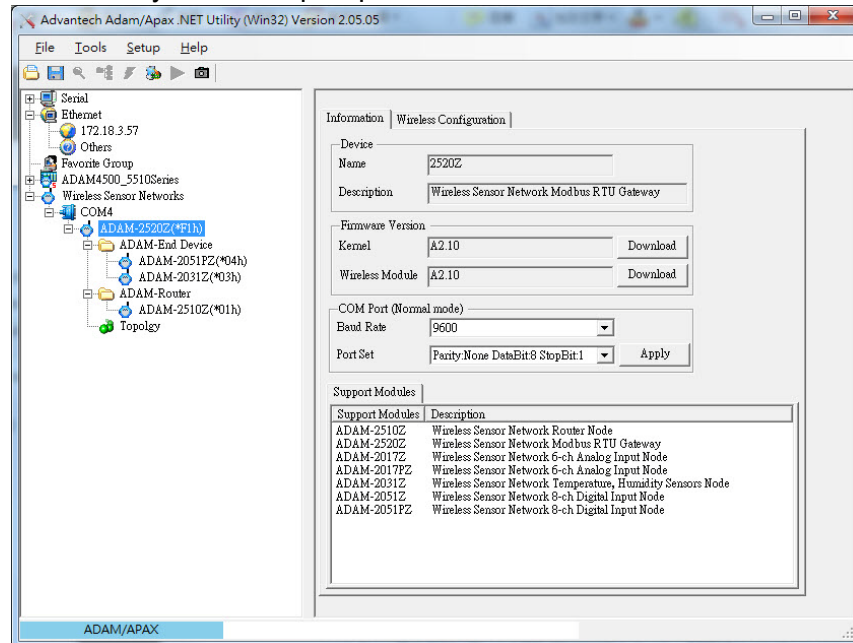

Figure 5.11 Information page of ADAM-2520Z

Select the "Wireless Configuration" page.

1. Set PAN ID and RF Channel to host a PAN for wireless communication in **Normal Mode**.
2. Set Slave ID for Modbus communication in **Normal Mode**.

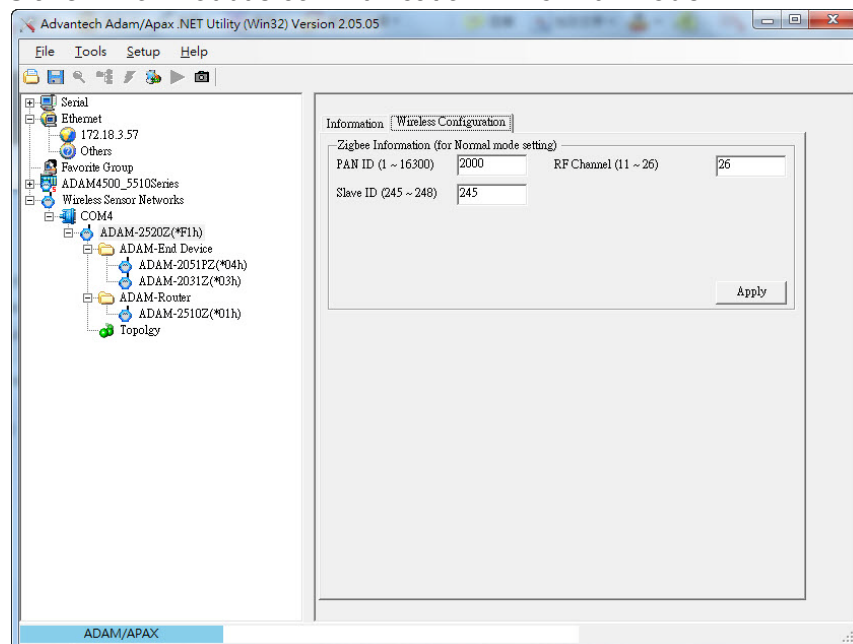

Figure 5.12 Wireless Configuration page of the ADAM-2520Z.

5.3.2.2 Router - ADAM-2510Z

Click the ADAM-2510Z, it will display the Information, Wireless Configurations and Device Status. In the Information page, users can download the firmware to the ADAM-2510Z if there is any upgrade firmware from the Advantech.

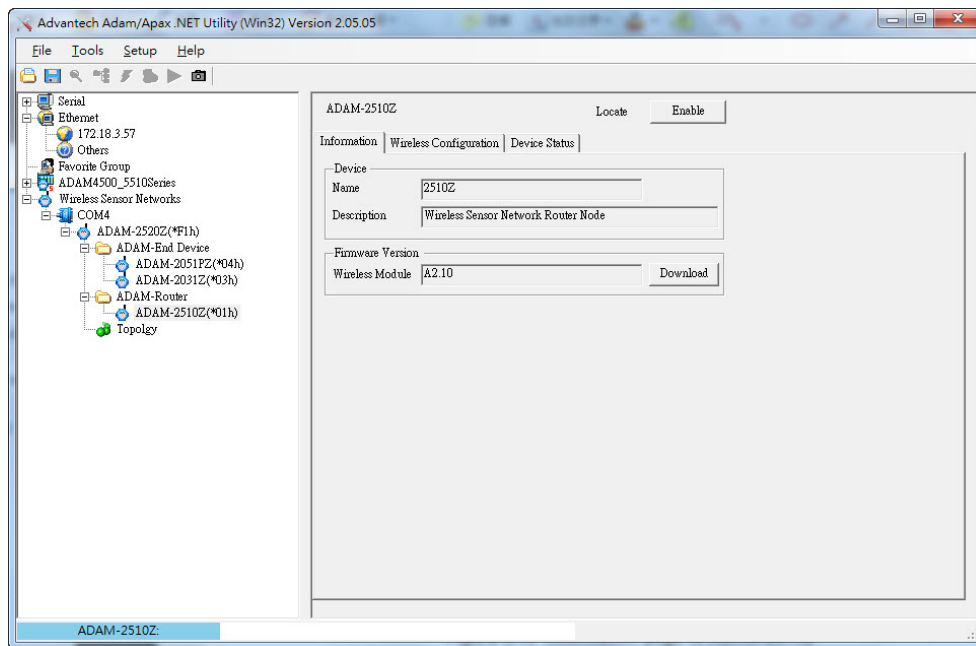

Figure 5.13 Information page of ADAM-2510Z

In the “Wireless Configuration” page:

1. PAN ID and RF Channel that are the same as the coordinator to host a PAN for wireless communication in Normal Mode.
2. The Slave ID should be unique within this PAN, and this number would also be the Modbus Slave ID which represents this node.
3. Parent Address is the previous node that this node connected to, coordinator always has Address 0x0000. So, in following figure, this node is directly connected to coordinator without any hopping.
4. Short Address is the unique address for the physical layer, this address is auto assigned.
5. Data Cycle will define the data update period of this node. For router node, in normal mode, the router will update its information according this data cycle. However, when its children nodes update information, it will also update its information to its parent node in the meantime. In other words, the Router node does not have a sleep mode, it will stay awake to listen to the information from its children and update to its parent node.

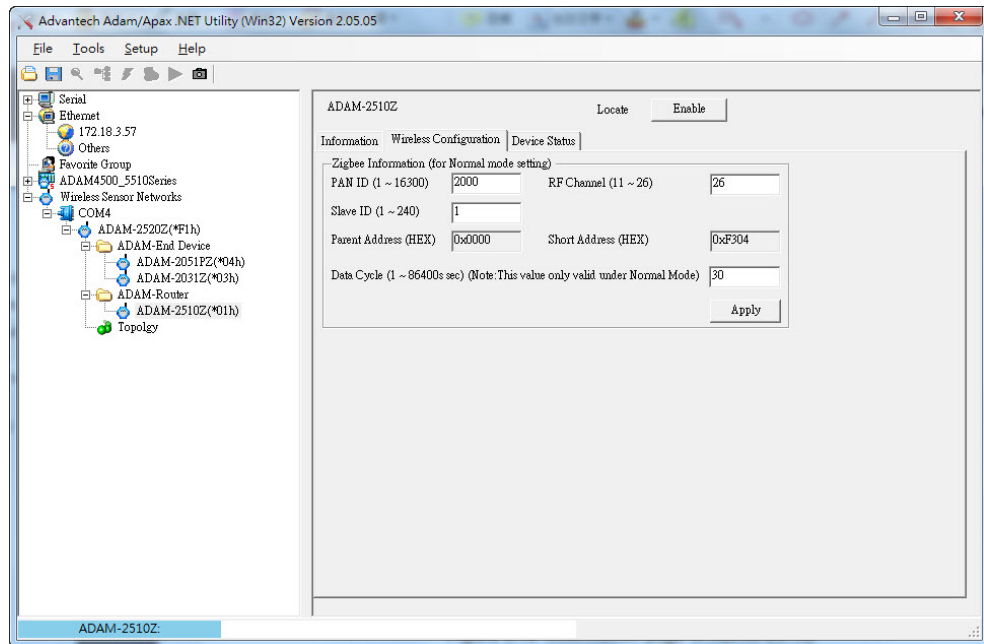

Figure 5.14 Wireless Configuration page of ADAM-2510Z

In the Device Status page, user can check the Module Status, Link Quality, Battery Status and External Power of a device.

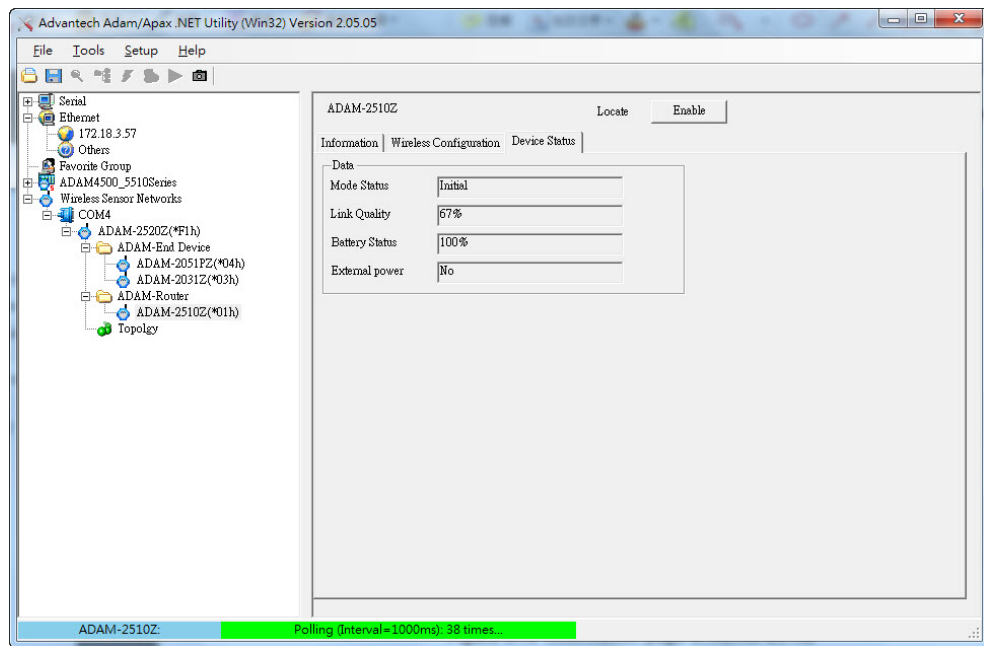

Figure 5.15 The Device Status page of the ADAM-2510Z

5.3.2.3 End Device - ADAM-2017PZ, ADAM-2031Z, ADAM-2051Z, ADAM-2051PZ

Click the ADAM End device icon, it will display the Information and Wireless Configuration pages in Status Display area. In the Information page, user can download the firmware to the ADAM End device if have any upgrade firmware from Advantech.

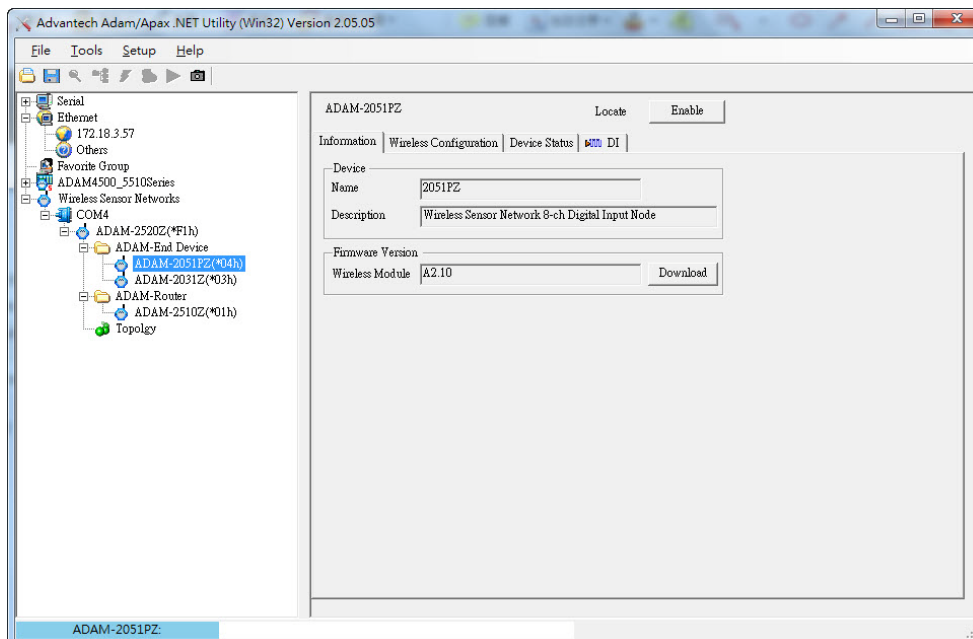

Figure 5.16 Information Page

In the "Wireless Configuration" page:

1. PAN ID and RF Channel are the same as the coordinator to host a PAN for wireless communication in Normal Mode.
2. The Slave ID should be unique within this PAN, and this number is also the Modbus Slave ID to represent this node.
3. Parent Address is the previous node that this node connected to, the coordinator always has an Address of 0x0000. So, in following figure, this node is directly connected to coordinator without any hopping.
4. Short Address is the unique address for the physical layer, this address is automatically assigned.
5. Data Cycle will define the data update period of this node. For end devices, in normal mode, the end device will update its information according this data cycle, it will then go into sleep mode if powered by a battery.

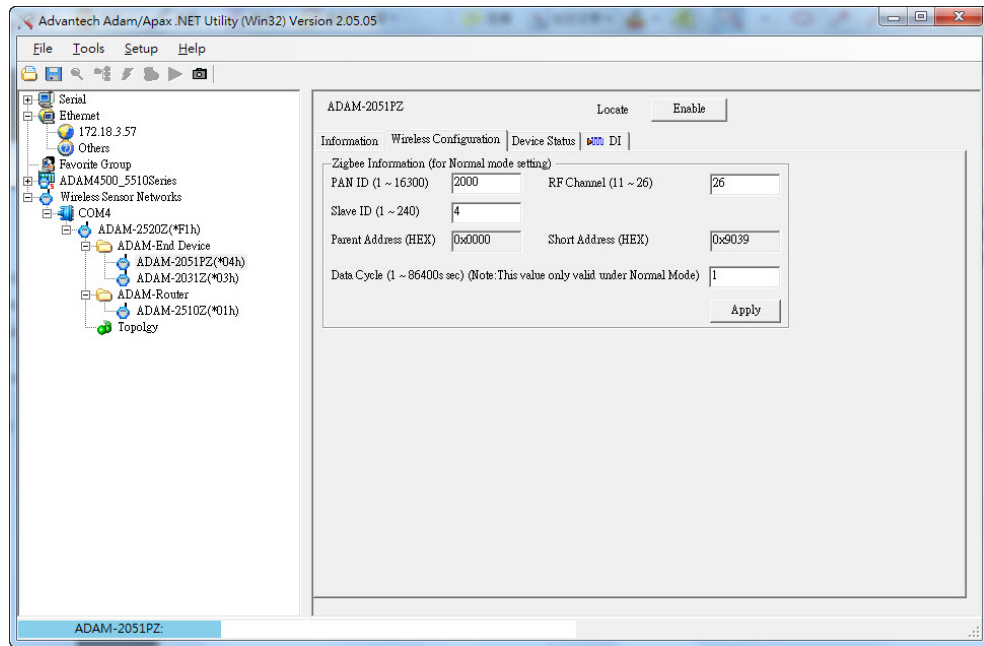

Figure 5.17 Wireless Configuration page

In the Device Status page, user can check the Module Status, Link Quality, Battery Status and External Power of a device.

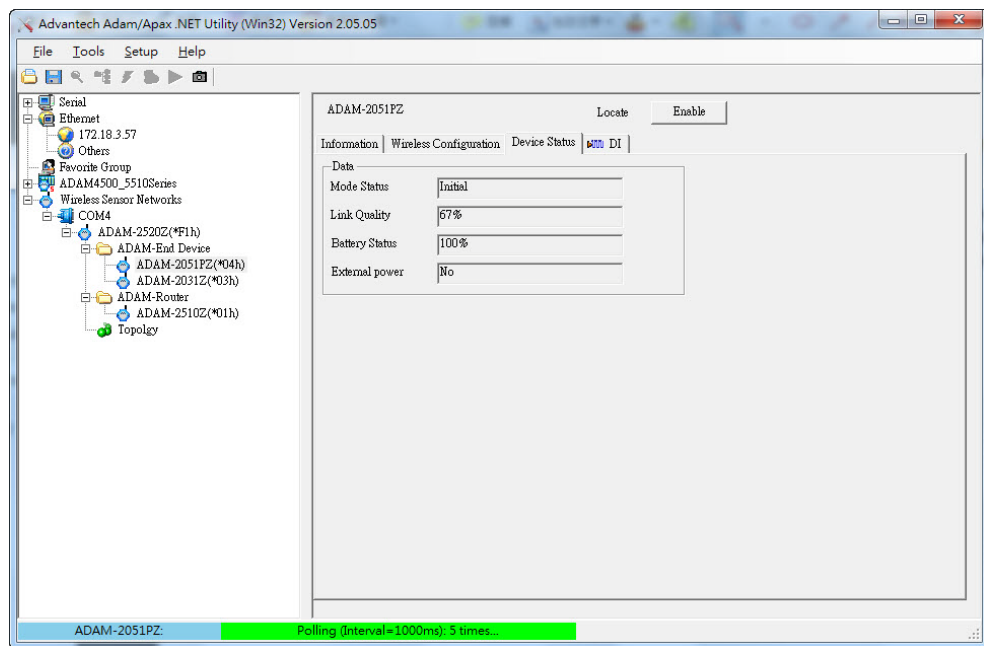

Figure 5.18 The Device Status page

In the Signal page, user can check the physical value and Modbus address of the device by related channel or sensor.

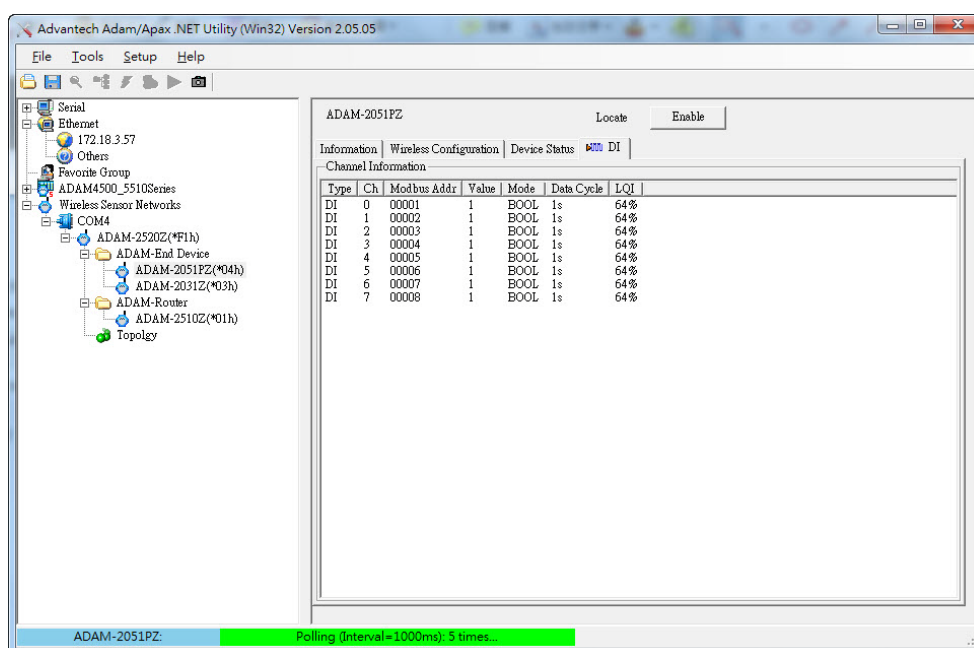



Figure 5.19 The Signal page

Note!  During the process of device firmware update, the data of firmware will be transferred from the coordinator to the end devices through the wireless communication. Due to the environment limitation or the interference from other wireless equipment, the complete time of firmware update is dependent on the wireless environment in the real site. Under the non-interference environment and good level of LQI signal, firmware update for an end device would normally be completed in 3 minutes.

5.3.3 Network Topology of ADAM-2000 Series

After the ADAM-2000 devices have been discovered, all the devices will be listed on the Tree View and the Topology also lists the relations between devices in advance. Click the Topology, the relations of ADAM-2000 devices will be illustrated in the Topology page. There are three components with model name and status listed on the Topology. The "C" represents the role of Coordinator, the "R" represents the role of Router and the "E" represents the role of End Device. You can scroll position on the screen using a mouse.

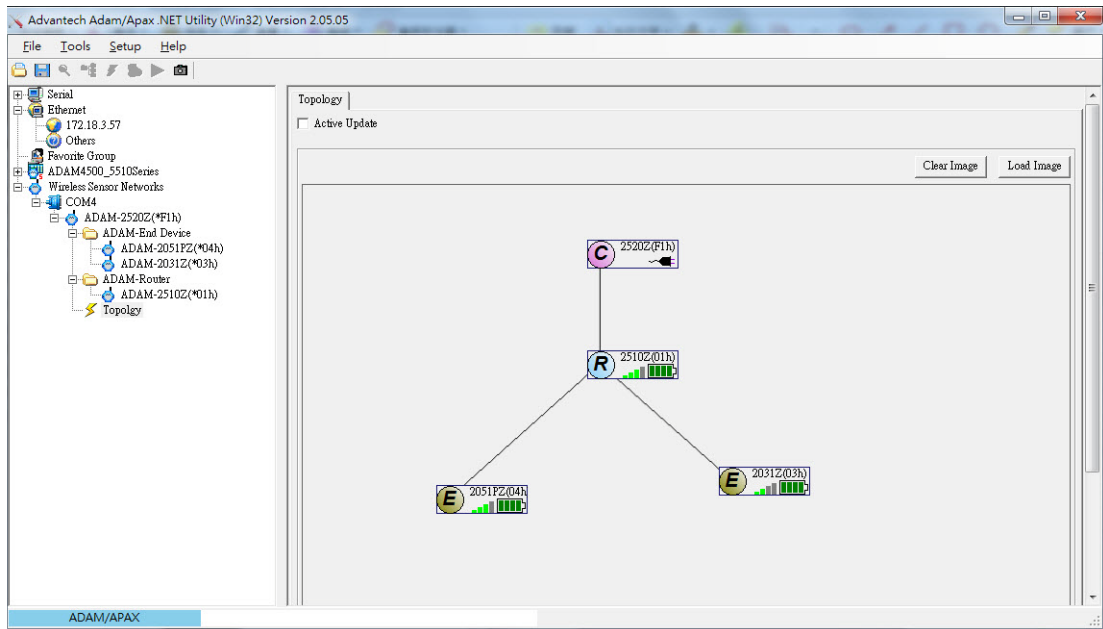

Figure 5.20 Topology of the ADAM-2000 series

The function allows user to put a picture on the background and drag the components to any positions of the background. With the function, user can easily maintain and check the status of the ADAM-2000 network.

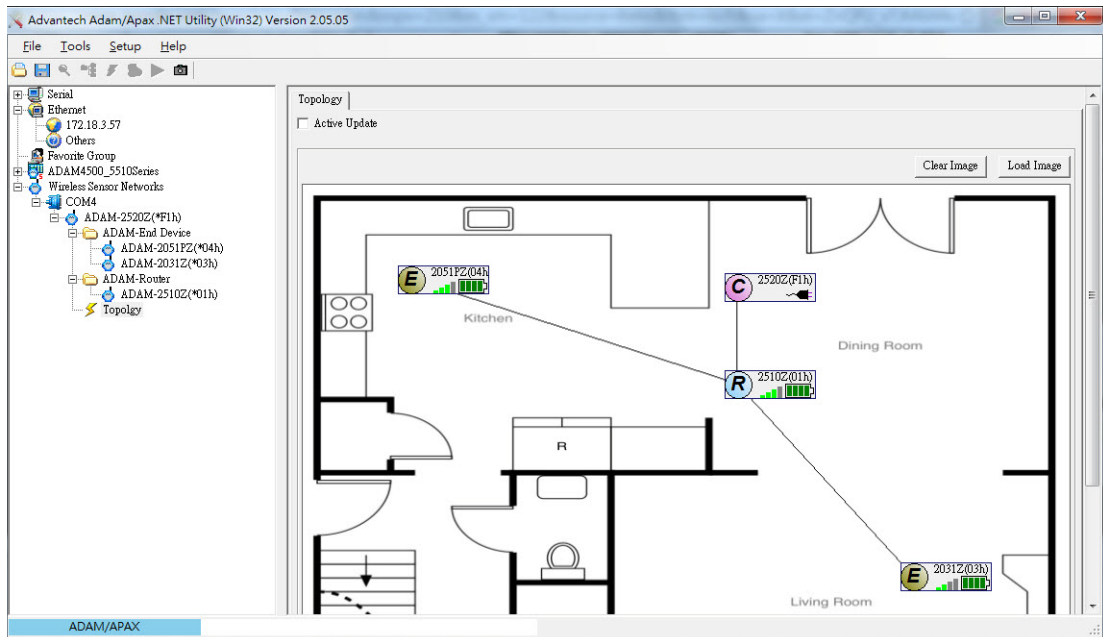

Figure 5.21 Topology of ADAM-2000 network with specific background image

5.3.4 Module Locate Function of ADAM-2000 Series (Except ADAM-2520Z)

Knowing where module positions are located is one of the most important things for users creating a network topology with a utility. In the initial mode, the AdamApax .NET utility supports locate function for user to find out where current module positions are located.

Locate function allows user to locate more than one module at the same time, user just need to select a module that you want to be located then click “Enable” button in status display area as Figure 5.22. Located module's LED indicator of Level Index will keep flashing when it is located, when click “Disable” button that module locate function will be terminated and LED indicator of Level Index will stop flashing.

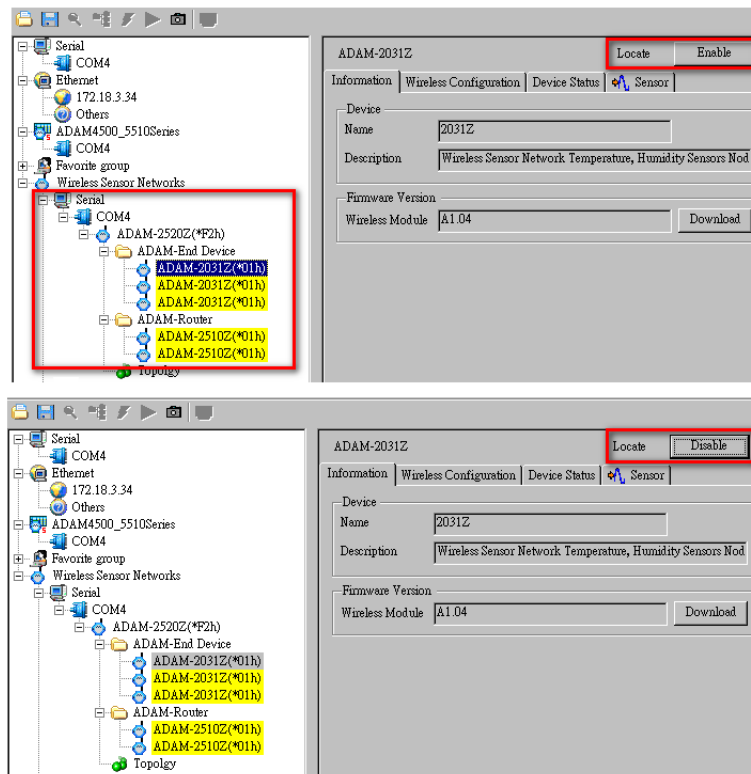

Figure 5.22 Node Tree

5.3.5 Group Configuration

The Group Configuration is an efficient function which can support user to configure multiple end devices.

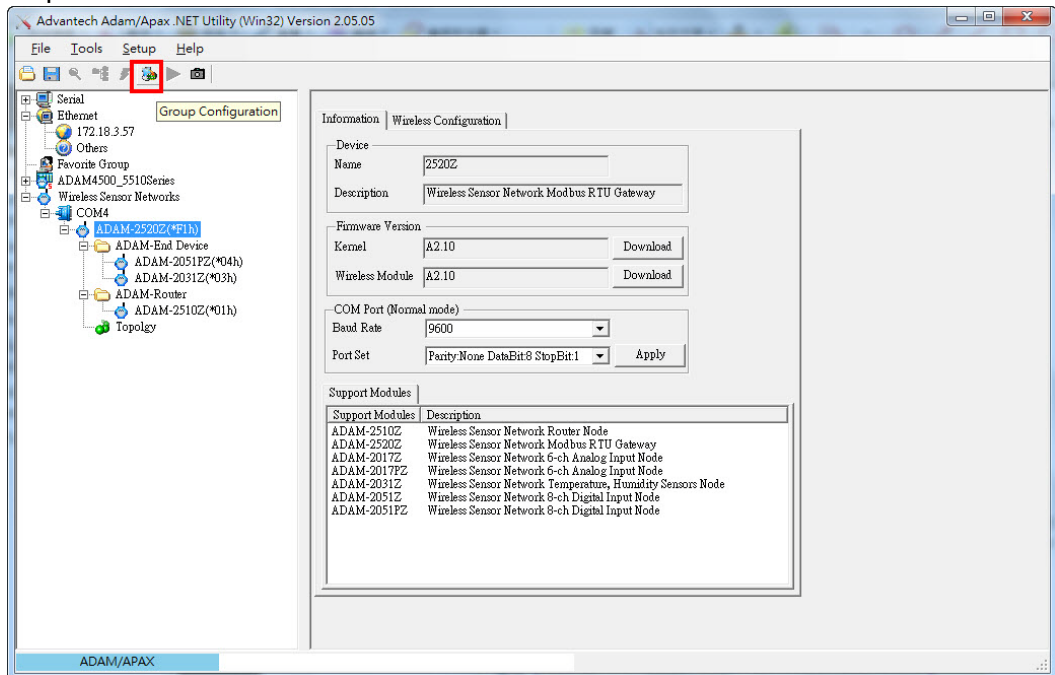

Figure 5.23 Group Configuration

The firmware configuration option, can perform firmware updates for multiple end devices which users select. After selecting the types of modules and specifying the file source, the selected modules would be updated by sequence.

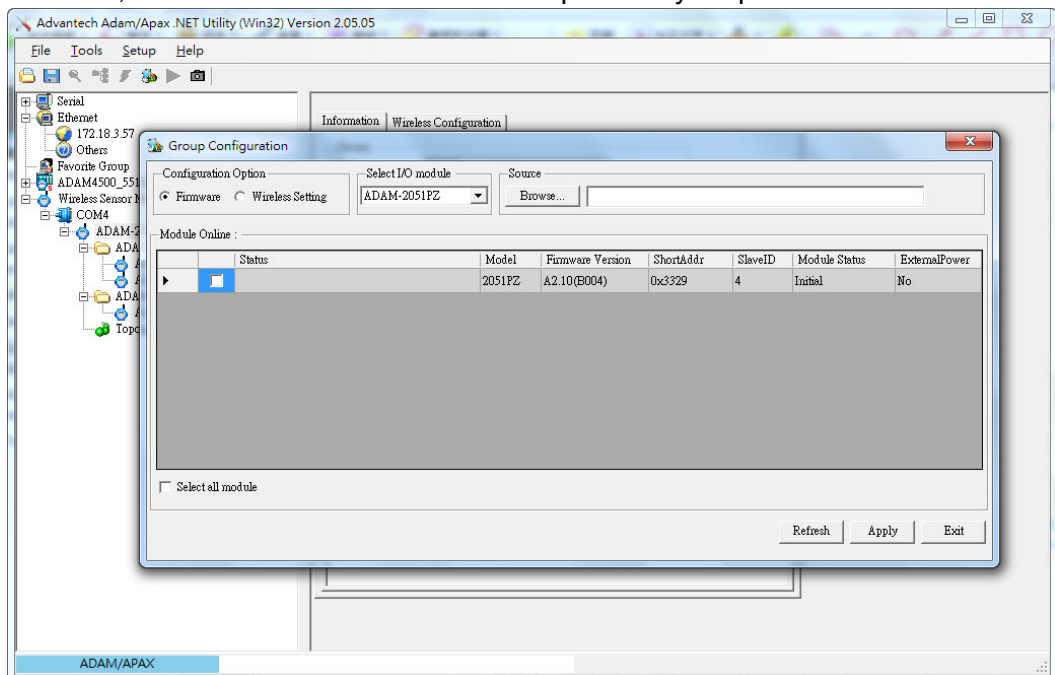

Figure 5.24 Firmware Update in Group Configuration

The wireless setting option, user can set wireless settings for multiple modules which are selected.

Initial Mode: PanID, Slave ID, RF Channel, and Data Cycle

Normal Mode: Slave ID and Data Cycle.

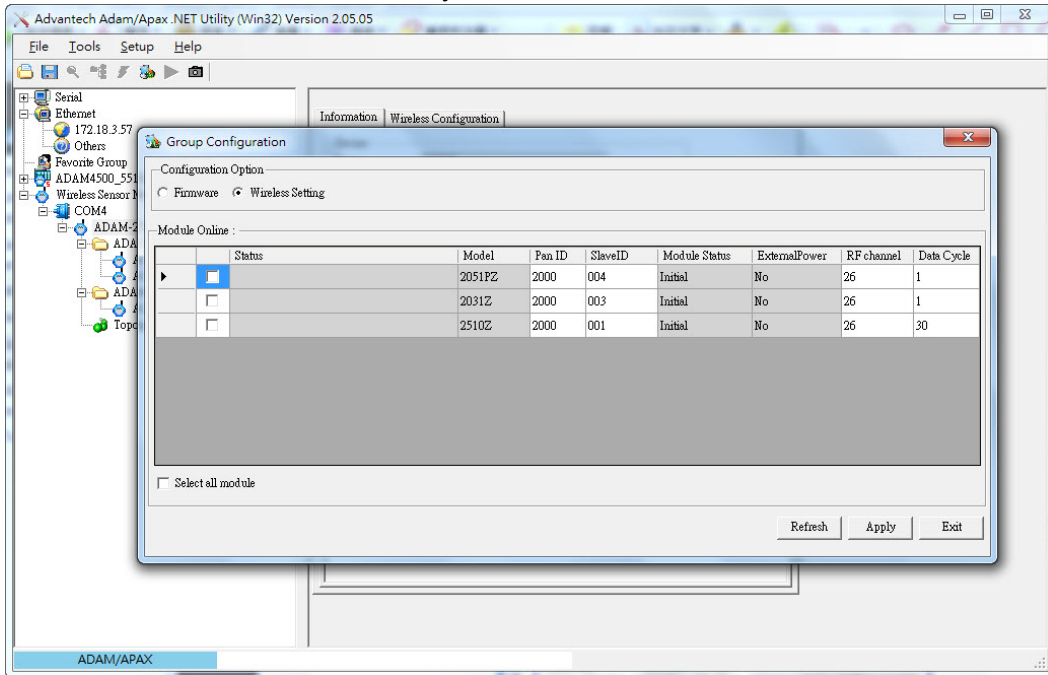

Figure 5.25 Wireless Setting of Group Configuration

Appendix **A**

ADAM-2000 Series
Functions

A.1 Introduction

ADAM-2000 series supports Modbus RTU protocol and serves as Modbus slave devices that takes commands from a Modbus master. Each module has its own unique Modbus ID such that master can address each individual slave. The ADAM-2000 series are the Modbus RTU ready communication solution for Wireless Sensor Network data acquisition applications.

A.2 ADAM-2000 I/O Modbus Mapping Table

To use the Modbus devices properly, the Modbus ID, Function code, Register Address and Value must be properly configured. In this section, you can find the detail Modbus information of the ADAM-2000 series.

Table A.1: Modbus ID Table of ADAM-2000 series

Function	Modbus ID Range
Coordinator	241 ~ 244 (Initial Mode), 245 ~ 248(Normal Mode)
Router	1~240
End Device	1~240

Note! * Modbus registers below are based on the firmware version A2.10 B03 and later on.



A.2.1 ADAM-2520Z

Wireless Sensor Network Modbus RTU Gateway

03 Read Holding Registers

Table A.2: ADAM-2520Z Mapping Table

Address 4x	Description	Attribute	Value
40211	Module Name 1	Read	0x2520
40212	Module Name 2	Read	0x5A00 (ASCII Code of 'Z')
40213	Wireless Module Firmware Version 1	Read	Version Number (ex: 0xA210 means version A2.10)
40214	Wireless Module Firmware Version 2	Read	Build Version Number (ex: 0x0003 means version B03)
40217	Kernel Firmware Version 1	Read	Version Number (ex: 0xA210 means version A2.10)
40218	Kernel Firmware Version 2	Read	Build Version Number (ex: 0x0500 means version B05)
40301	Module Status	Read	Bit 0: 0; Initial Mode
			Bit 0: 1; Normal Mode
			Bit 1: 0; *No External Power Input
			Bit 1: 1; External Power Input
40303	Battery Level	Read	0x0000; Low
			0x4000; Poor
			0x8000; Normal
			0xC000; Good
			0xFFFF; Excellent
40304	Connection failed threshold (N times of data cycle)	Read	0x0002
40305	Disconnection threshold (N times of connection failed threshold)	Read	0x0002
40306	Link Status	Read	Bit 0: Connected Bit 1: Link Failure Bit 2: Disconnected Bit 3: Connecting
40310	Device Short Address	Read	0x0000~0xFFFF

Note! * It should be USB or battery power input. It does not recommend user to use battery as power source for ADAM-2520Z.



A.2.2 ADAM-2510Z

Wireless Sensor Network Router Node

03 Read Holding Registers

Table A.3: ADAM-2510Z Mapping Table

Address 4x	Description	Attribute	Value
40211	Module Name 1	Read	0x2510
40212	Module Name 2	Read	0x5A00 (ASCII Code of 'Z')
40213	Wireless Module Firmware Version 1	Read	Version Number (ex: 0xA210 means version A2.10)
40214	Wireless Module Firmware Version 2	Read	Build Version Number (ex: 0x0003 means version B03)
40301	Module Status	Read	Bit 0: 0; Initial Mode
			Bit 0: 1; Normal Mode
			Bit 1: 0; No External Power Input
			Bit 1: 1; External Power Input
40302	LQI	Read	0x0000~0x00FF 0x0000: No Signal 0x00FF: Excellent
40303	Battery Level	Read	0x0000; Low
			0x4000; Poor
			0x8000; Normal
			0xC000; Good
40304	Device Inactive Period (Upper word)	Read	0 ~ 259200 seconds; Maximum 3 days record (Total 51840 steps; 5 seconds per step)
40305	Device Inactive Period (Lower word)		
40306	Link Status	Read	Bit 0: Connected Bit 1: Link Failure Bit 2: Disconnected Bit 3: Connecting
40307	Data Cycle Time (Upper)	Read	0x00000001~0x00015180 (1 ~ 864000 seconds)
40308	Data Cycle Time (Lower)		
40309	LQI Percentage	Read	0x0000~0x0064 (0~100%)
40310	Device Short Address	Read	0x0000~0xFFFF
40311	Parent Address	Read	0x0000~0xFFFF

A.2.3 ADAM-2017PZ

Wireless Sensor Network 6-ch Analog Input Node

01 Read Coils

03 Read Holding Registers

Table A.4: ADAM-2017PZ Mapping Table

Address	Description	Attribute	Value
00121	AI Ch 0 Burn-Out Flag	Read	1: Burn Out
00122	AI Ch 1 Burn-Out Flag	Read	1: Burn Out
00123	AI Ch 2 Burn-Out Flag	Read	1: Burn Out
00124	AI Ch 3 Burn-Out Flag	Read	1: Burn Out
00125	AI Ch 4 Burn-Out Flag	Read	1: Burn Out
00126	AI Ch 5 Burn-Out Flag	Read	1: Burn Out
40001	AI Value Ch 0	Read	0x0000~0xFFFF; Selected input range
40002	AI Value Ch 1	Read	0x0000~0xFFFF; Selected input range
40003	AI Value Ch 2	Read	0x0000~0xFFFF; Selected input range
40004	AI Value Ch 3	Read	0x0000~0xFFFF; Selected input range
40005	AI Value Ch 4	Read	0x0000~0xFFFF; Selected input range
40006	AI Value Ch 5	Read	0x0000~0xFFFF; Selected input range
40101	AI Status Ch 0	Read	*See the table below
40102			
40103	AI Status Ch 1	Read	*See the table below
40104			
40105	AI Status Ch 2	Read	*See the table below
40106			
40107	AI Status Ch 3	Read	*See the table below
40108			
40109	AI Status Ch 4	Read	*See the table below
40110			
40111	AI Status Ch 5	Read	*See the table below
40112			
40201	AI Type Ch 0	Read	*See the table below
40202	AI Type Ch 1	Read	*See the table below
40203	AI Type Ch 2	Read	*See the table below
40204	AI Type Ch 3	Read	*See the table below
40205	AI Type Ch 4	Read	*See the table below
40206	AI Type Ch 5	Read	*See the table below
40211	Module Name 1	Read	0x2017
40212	Module Name 2	Read	0x5A00 (ASCII Code of 'Z')
40213	Wireless Module Firmware Version 1	Read	Version Number (ex: 0xA210 means version A2.10)
40214	Wireless Module Firmware Version 2	Read	Build Version Number (ex: 0x0003 means version B03)
40301	Module Status	Read	Bit 0: 0; Initial Mode
			Bit 0: 1; Normal Mode
			Bit 1: 0; No External Power Input
			Bit 1: 1; External Power Input

Table A.4: ADAM-2017PZ Mapping Table

40302	LQI	Read	0x0000~0x00FF 0x0000: No Signal 0x00FF: Excellent
40303	Battery Level	Read	0x0000; Low 0x4000; Poor 0x8000; Normal 0xC000; Good 0xFFFF; Excellent
40304	Device Inactive Period (Upper word)	Read	0 ~ 259200 seconds; Maximum 3 days record (Total 51840 steps; 5 seconds per step)
40305	Device Inactive Period (Lower word)		
40306	Link Status	Read	Bit 0: Connected Bit 1: Link Failure Bit 2: Disconnected Bit 3: Connecting
40307	Data Cycle Time (Upper word)	Read	0x00000001~0x00015180 (1 ~ 864000 seconds)
40308	Data Cycle Time (Lower word)		
40309	LQI Percentage	Read	0x0000~0x0064 (0~100%)
40310	Device Short Address	Read	0x0000~0xFFFF
40311	Parent Address	Read	0x0000~0xFFFF

*ADAM-2017PZ AI Type Code (Range Code)	
Input Range	Value
+/- 10V	0x0143
+/- 5 V	0x0142
+/- 1 V	0x0140
+/- 500 mV	0x0104
+/- 150 mV	0x0103
+/- 20 mA	0x0181
0 ~ 20 mA	0x0182
4 ~ 20 mA	0x0180
*ADAM-2017PZ AI Status (1st Register at Low Address)	
Status Description	Bit Order
A/D Convert Timeout (Fail)	0
Over Range	1
Under Range	2
Open Circuit (Burn-Out)	3
Reserved	4~8
Zero Span Calibration Error	9
Factory Calibration error	10
Reserved	11~15
*ADAM-2017PZ AI Status (2nd Register at Low Address)	
Status Description	Bit Order
Reserved	0 ~ 15

A.2.4 ADAM-2031Z

Wireless Sensor Network Temperature and Humidity Sensors Node

03 Read Holding Registers

Table A.5: ADAM-2031Z Mapping Table

Address 4X	Description	Attribute	Value
40001	Temperature Input	Read	0x0000 ~ 0xFFFF*
40002	Humidity Input	Read	0x0000 ~ 0xFFFF**
40211	Module Name 1	Read	0x2031
40212	Module Name 2	Read	0x5A00 (ASCII Code of 'Z')
40213	Wireless Module Firmware Version 1	Read	Version Number (ex: 0xA210 means version A2.10)
40214	Wireless Module Firmware Version 2	Read	Build Version Number (ex: 0x0003 means version B03)
40301	Module Status	Read	Bit 0: 0; Initial Mode
			Bit 0: 1; Normal Mode
			Bit 1: 0; No External Power Input
			Bit 1: 1; External Power Input
40302	LQI	Read	0x0000~0x00FF; 0x0000: No Signal 0x00FF: Excellent
40303	Battery Level	Read	0x0000; Low
			0x4000; Poor
			0x8000; Normal
			0xC000; Good
			0xFFFF; Excellent
40304	Device Inactive Period (Upper word)	Read	0 ~ 259200 seconds; Maximum 3 days record (Total 51840 steps; 5 seconds per step)
40305	Device Inactive Period (Lower word)		
40306	Link Status	Read	Bit 0: Connected Bit 1: Link Failure Bit 2: Disconnected Bit 3: Connecting
40307	Data Cycle Time (Upper)	Read	0x00000001~0x00015180 (1 ~ 864000 seconds)
40308	Data Cycle Time (Lower)		
40309	LQI Percentage	Read	0x0000~0x0064 (0~100%)
40310	Device Short Address	Read	0x0000~0xFFFF
40311	Parent Address	Read	0x0000~0xFFFF

Note! * The temperature T is calculated by inserting temperature signal output S_T into the following formula (result is in °C).



$$T = -46.85 + \left[175.72x \frac{S_T}{2^{16}} \right]$$

Note!  ****** The humidity **RH** is calculated by inserting humidity signal output **S_{RH}** into the following formula (result is in %RH)

$$RH = -6 + \left[125x \frac{S_{RH}}{2^{16}} \right]$$

A.2.5 ADAM-2051Z

Wireless Sensor Network 8-ch Digital Input Node

01 Read Coils

03 Read Holding Registers

Table A.6: ADAM-2051Z Mapping Table

Address	Description	Attribute	Value
00001	DI 0	Read	Digital Input Value
00002	DI 1	Read	Digital Input Value
00003	DI 2	Read	Digital Input Value
00004	DI 3	Read	Digital Input Value
00005	DI 4	Read	Digital Input Value
00006	DI 5	Read	Digital Input Value
00007	DI 6	Read	Digital Input Value
00008	DI 7	Read	N/A
40001	The Value for All DI	Read	Bit 0 ~ 7 of reading value represent DI 0 ~ 7
40211	Module Name 1	Read	0x2051
40212	Module Name 2	Read	0x5A00 (ASCII Code of 'Z')
40213	Wireless Module Firmware Version 1	Read	Version Number (ex: 0xA210 means version A2.10)
40214	Wireless Module Firmware Version 2	Read	Build Version Number (ex: 0x0003 means version B03)
40301	Module Status	Read	Bit 0: 0; Initial Mode Bit 0: 1; Normal Mode Bit 1: 0; No External Power Input Bit 1: 1; External Power Input
40302	LQI	Read	0x0000~0x00FF; 0x0000: No Signal 0x00FF: Excellent
40303	Battery Level	Read	0x0000; Low 0x4000; Poor 0x8000; Normal 0xC000; Good 0xFFFF; Excellent
40304	Device Inactive Period (Upper word)	Read	0 ~ 259200 seconds; Maximum 3 days record (Total 51840 steps; 5 seconds per step)
40305	Device Inactive Period (Lower word)		
40306	Link Status	Read	Bit 0: Connected Bit 1: Link Failure Bit 2: Disconnected Bit 3: Connecting
40307	Data Cycle Time (Upper)	Read	0x00000001~0x00015180 (1 ~ 864000 seconds)
40308	Data Cycle Time (Lower)		
40309	LQI Percentage	Read	0x0000~0x0064 (0~100%)
40310	Device Short Address	Read	0x0000~0xFFFF
40311	Parent Address	Read	0x0000~0xFFFF

A.2.6 ADAM-2051PZ

Wireless Sensor Network 8-ch Digital Input Node with Power Amplifier

01 Read Coils

03 Read Holding Registers

Table A.7: ADAM-2051PZ Mapping Table

Address	Description	Attribute	Value
00001	DI 0	Read	Digital Input Value
00002	DI 1	Read	Digital Input Value
00003	DI 2	Read	Digital Input Value
00004	DI 3	Read	Digital Input Value
00005	DI 4	Read	Digital Input Value
00006	DI 5	Read	Digital Input Value
00007	DI 6	Read	Digital Input Value
00008	DI 7	Read	Digital Input Value
40001	The Value for All DI	Read	Bit 0 ~ 7 of reading value represent DI 0 ~ 7
40211	Module Name 1	Read	0x2051
40212	Module Name 2	Read	0x505A (PZ)
40213	Wireless Module Firmware Version 1	Read	Version Number (ex: 0xA210 means version A2.10)
40214	Wireless Module Firmware Version 2	Read	Build Version Number (ex: 0x0300 means version B03)
40301	Module Status	Read	Bit 0: 0; Initial Mode Bit 0: 1; Normal Mode Bit 1: 0; No External Power Input Bit 1: 1; External Power Input
40302	LQI	Read	0x0000~0x00FF; 0x0000: No Signal 0x00FF: Excellent
40303	Battery Level	Read	0x0000; Low 0x4000; Poor 0x8000; Normal 0xC000; Good 0xFFFF; Excellent
40304	Device Inactive Period (Upper word)	Read	0 ~ 259200 seconds; Maximum 3 days record (Total 51840 steps; 5 seconds per step)
40305	Device Inactive Period (Lower word)		
40306	Link Status	Read	Bit 0: Connected Bit 1: Link Failure Bit 2: Disconnected Bit 3: Connecting
40307	Data Cycle Time (Upper)	Read	0x00000001~0x00015180 (1 ~ 864000 seconds)
40308	Data Cycle Time (Lower)		
40309	LQI Percentage	Read	0x0000~0x0064 (0~100%)
40310	Device Short Address	Read	0x0000~0xFFFF
40311	Parent Address	Read	0x0000~0xFFFF

Appendix **B**

Troubleshooting

B.1 Troubleshooting

Q1: Why is the Error LED blinking?

A1:

1. The Coordinator is not hosting a PAN yet. The PAN ID and Channel might be occupied by another Coordinators. Change to different PAN ID and Channel in initial mode.
2. The Router/End Device is not joining a PAN. Check if there is a coordinator with specified PAN ID and Channel to join.
3. Battery level is low.
4. Network is associating.

Q2: Why does the amber LED on Coordinator automatically add a count in initial mode?

A2: The Coordinator will automatically add the Pair ID while there is another Coordinator nearby and can be detected.

Q3: What are the functions of the amber LEDs in Router and End Device?

A3:

1. Press side button 1 time for LQI.
2. Press side button 2 times for battery level.
3. Press side button 3 times for network association
4. Press side button 5 times to change the Pair ID to associate with the specified Pair ID coordinator.

Q4: Why are all the amber LEDs on coordinator blinking while operating in initial mode?

A4: Four Pair ID can be selected in initial mode of coordinators. If there are five coordinators set in initial mode at the same time, the last one will blink to indicate there are no available Pair ID to use.

Q5: Does the ADAM-2520Z support the HW/SW flow control of serial communication?

A5: The ADAM-2520Z does not support the HW/SW flow control and the user application/software must turn off the HW/SW flow control.

Q6: Can I use the rechargeable battery as the ADAM-2000 series power input?

A6: The ADAM-2000 can not use rechargeable batteries. Besides, the battery will not be charged while using the external power. We suggest using Energizer L91 Ultimate Lithium AA battery.

Q7: Does the utility support Microsoft Windows 7 32 & 64 bit versions?

A7: Yes, AdamApax .NET Utility can support Microsoft Windows 7 32 & 64 bit versions from Advantech AdamApax .NET Utility Ver 2.05.02.

Q8: While switching communication interface from RS-485 to USB, it sometimes will cause USB unworkable.

A8: If this situation occurs, re-plug in the USB cable.

B.2 Notice

1. When there are 4 set of devices being coordinated at the same time, the level Index light will be lit by turns.
2. Devices in initial mode will in high power consumption status, beware of your power status when using batteries.
3. When using the AdamApax .NET Utility the initial value of an ADAM-2051Z is 1. The ADAM-2051Z also supports dry contacts.
4. If customers want to connect an ADAM-2000 model with SCADA software, they can use AdamApax .NET Utility to get ADAM-2000 system parameters then SCADA software can connect them according these parameters.

Note! ADAM-2000 models do not currently support Mod-scan. We will support this feature in the future.



ADAM-2000 models do not currently support OPC sever., We will support this feature in the future.

5. ADAM-2000 models do not support the “My Favorite” function in the AdamApax .NET Utility.
6. When two set of devices are to be coordinated at the same time, the second set router and end-device connect to first set of devices.
7. When there are 2 sets of devices to coordinate with at the same time, they need to reset power to re-initial PAN ID if they want to connect to another set.
8. The device must not be co-located or operating in conjunction with any other antenna or transmitter. The changes or modifications not expressly approved by the party responsible for compliance could void the user's authority to operate the equipment.
9. The installation of the base unit should allow at least 20 centimeters between the base and persons to be in compliance with FCC RF exposure guidelines. For body worn operation, the portable part has been tested and meets FCC RF exposure guidelines.

ADVANTECH

eAutomation

www.advantech.com

Please verify specifications before quoting. This guide is intended for reference purposes only.

All product specifications are subject to change without notice.

No part of this publication may be reproduced in any form or by any means, electronic, photocopying, recording or otherwise, without prior written permission of the publisher.

All brand and product names are trademarks or registered trademarks of their respective companies.

© Advantech Co., Ltd. 2012