

RECTIFIERS

High Efficiency, 2.5A

UES1101 BYV27-50
 UES1102 BYV27-100
 UES1103 BYV27-150

2

FEATURES

- Very Fast Recovery Times
- Very Low Forward Voltage
- Small Size
- Convenient Package

DESCRIPTION

An axial leaded power rectifier useful in many switching applications. Particularly suited where very fast recovery and low forward voltage are required.

ABSOLUTE MAXIMUM RATINGS

	UES1101	UES1102	UES1103	BYV27-50	BYV27-100	BYV27-150
Peak Inverse Voltage, V_R	50V	100V	150V	50V	100V	150V
Maximum Average D.C. Output at $T_L = 75^\circ\text{C}$, $L = \frac{3}{8}"$, I_o	2.5A	2.5A	2.5A	2.5A	2.0A	2.0A
Non-Repetitive Surge Current at 8.3ms, I_{FSM}	35A	35A	35A	35A	50A	50A
Thermal Resistance at $L = \frac{3}{8}"$, $R_{\theta JC}$	38°C/W	38°C/W	38°C/W	38°C/W	46°C/W	46°C/W
Junction Operating Temperature, T_j	175°C	175°C	175°C	175°C	165°C	165°C
Operating and Storage Temperature Range	-55°C to +175°C					

ELECTRICAL SPECIFICATIONS

Type	Maximum Reverse Voltage V_R	Maximum Forward Voltage @		Maximum Reverse Current @ Rated V_R		Maximum Reverse Recovery Time*
		$T_j = 25^\circ\text{C}$	$T_j = 100^\circ\text{C}$	$T_j = 25^\circ\text{C}$	$T_j = 100^\circ\text{C}$	
UES1101 UES1102 UES1103	50V 100V 150V	.975V @ 2A	.895V @ 2A	2 μA	50 μA	25nS
BYV27-50 BYV27-100 BYV27-150	50V 100V 150V	1.25V @ 5A	.85V @ 2.5A	1 μA	150 μA	25nS

*Measured in circuit $I_F = \frac{1}{2}A$, $I_R = 1.0A$, $I_{REC} = \frac{1}{4}A$

MECHANICAL SPECIFICATIONS

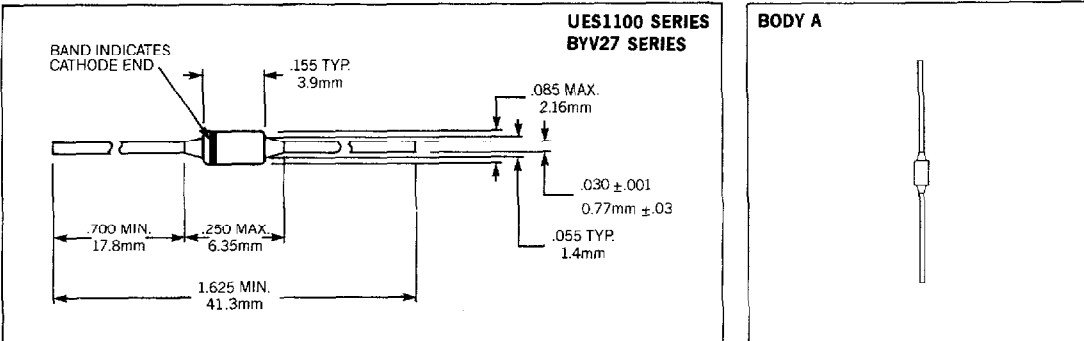

THESE DEVICES ALSO AVAILABLE IN SURFACE MOUNT PACKAGE. SEE SECTION 10

Microsemi Corp.
Watertown
 The diode experts

Output Current vs. Lead Temperature

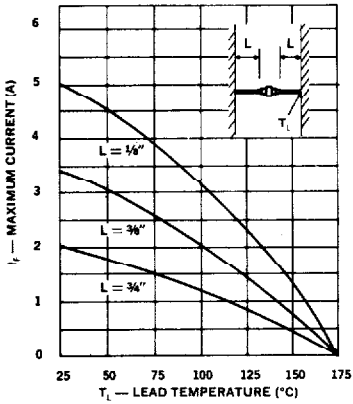

Typical Forward Current vs. Forward Voltage

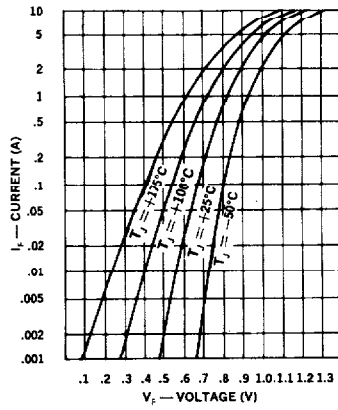

Typical Reverse Current vs. Voltage

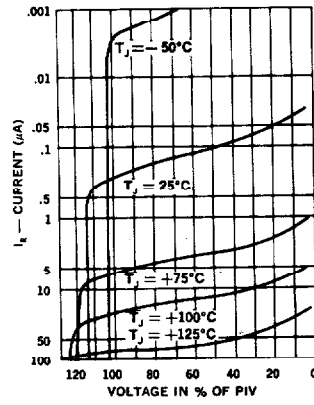

Forward Pulse Current vs. Duration

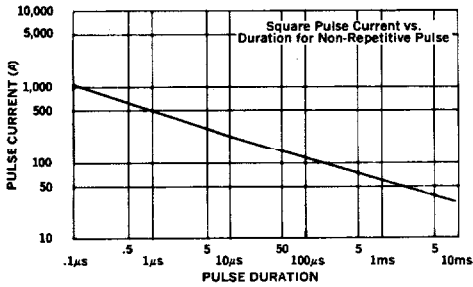

Multiple Surge Current vs. Duration

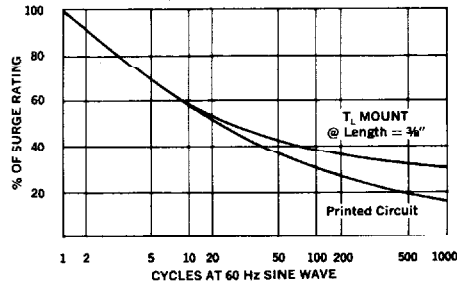

Reverse-Recovery Circuit

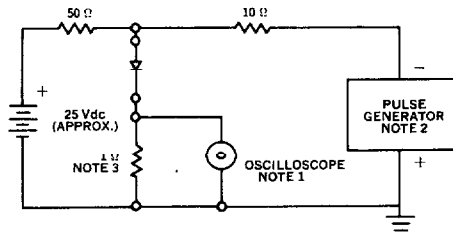

- Notes:**
- Oscilloscope: Rise time $\leq 3\text{ns}$; input impedance = 50Ω .
 - Pulse Generator: Rise time $\leq 8\text{ns}$; source impedance 10Ω .
 - Current viewing resistor, non-inductive, coaxial recommended.