

EVALUATION KIT
AVAILABLE

MAXIM

RF Power Detector

MAX2209

General Description

The MAX2209 is a wideband (800MHz to 2GHz) RF power detector. It takes an RF signal from the directional coupler at the input, and outputs a DC voltage proportional to the RF peak voltage. The change in output voltage versus temperature is very repeatable from part to part and enables a lookup table based on nominal behavior, minimizing the effective detection error to less than $\pm 0.5\text{dB}$ relative to room temperature.

The MAX2209 comes in a space-saving 2 x 2, 0.5mm pitch wafer-level package (WLP) and requires only two external components.

Applications

Dual-Band WCDMA Handsets
High-Speed Downlink Packet Access (HSDPA)
High-Speed Uplink Packet Access (HSUPA)

Features

- ◆ -25dBm to 0dBm Power Detection Range
- ◆ $\pm 0.5\text{dB}$ Detection Error Due to Temperature
- ◆ +2.7V to +5V Single-Supply Operation
- ◆ Space-Saving 4-Bump, 1mm² UCSP™ Package
- ◆ On-Chip 50 Ω Termination and DC-Blocking Capacitor

Ordering Information

PART	TEMP RANGE	PIN-PACKAGE	TOP MARK
MAX2209EBS+	-40°C to +85°C	4 UCSP	AGJ

+Denotes a lead(Pb)-free/RoHS-compliant package.

Pin Configuration/Functional Diagram/Typical Operating Circuit

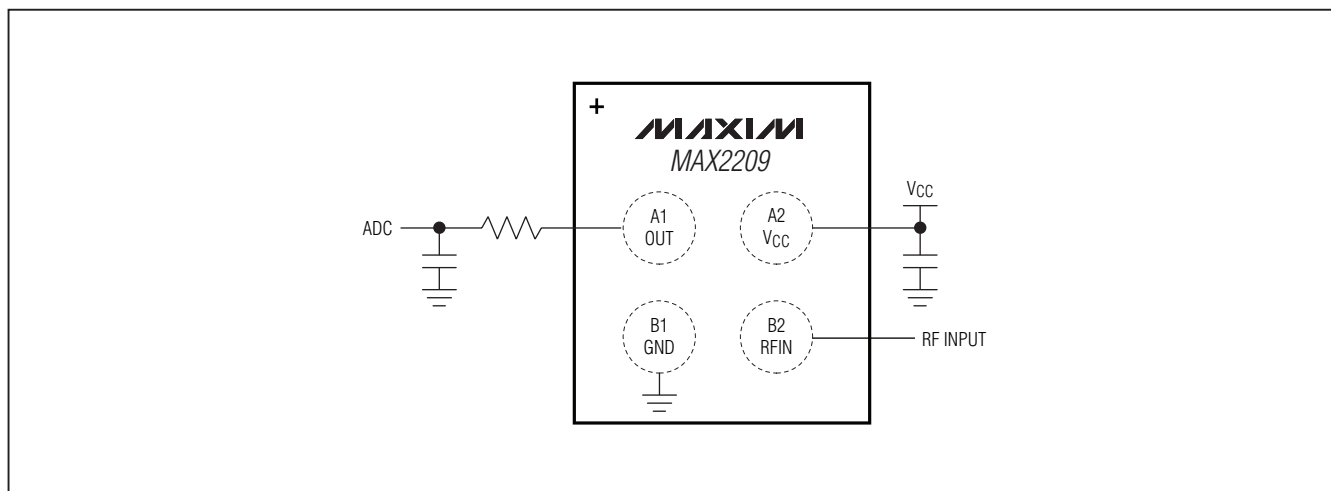

UCSP is a trademark of Maxim Integrated Products, Inc.

RF Power Detector

ABSOLUTE MAXIMUM RATINGS

V _{CC} to GND.....	-0.3V to +6V	Junction-to-Ambient Thermal Resistance (θ_{JA}) (Note 1).....	335°C/W
RFIN to GND	-0.3V to + (V _{CC} + 0.3V)	Operating Temperature Range.....	-40°C to +85°C
OUT to GND.....	-0.3V to + (V _{CC} + 0.3V)	Storage Temperature Range.....	-65°C to +160°C
RFIN Input Power	+10dBm	Junction Temperature	+150°C
Continuous Power Dissipation (T _A = +70°C)		Bump Temperature (soldering, Note 2)	
4-Bump WLP (derate 3mW/°C above +70°C).....	238mW	Infrared (15s).....	+260°C

Note 1: Package thermal resistances were obtained using the method described in JEDEC specification JESD51-7, using a 4-layer board. For detailed information on package thermal considerations, refer to www.maxim-ic.com/thermal-tutorial.

Note 2: For detailed information on soldering, refer to Application Note 1891: *Wafer-Level Packaging (WLP) and Its Applications*.

Stresses beyond those listed under "Absolute Maximum Ratings" may cause permanent damage to the device. These are stress ratings only, and functional operation of the device at these or any other conditions beyond those indicated in the operational sections of the specifications is not implied. Exposure to absolute maximum rating conditions for extended periods may affect device reliability.

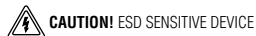

DC ELECTRICAL CHARACTERISTICS

(V_{CC} = 2.7V to 5.0V, T_A = -40°C to +85°C, no RF signal applied. Typical values are at V_{CC} = 2.8V, T_A = +25°C, unless otherwise noted.) (Note 3)

PARAMETER	CONDITIONS	MIN	TYP	MAX	UNITS
Supply Voltage		2.7		5.0	V
Supply Current			3.6	6	mA
Idle Output Voltage	V _{CC} = 2.8V, no RF signal		35		mV
Output Current Source Capability	P _{IN} = 0dBm, V _{OUT} forced to 0.5V	750	1800		μA
Output Current Sink Capability	No RF signal, V _{OUT} forced to 2V	300	525		μA

AC ELECTRICAL CHARACTERISTICS

(T_A = -40°C to +85°C, 50Ω system, V_{CC} = 2.8V. Typical values are at T_A = +25°C, unless otherwise noted.) (Note 3)

PARAMETER	CONDITIONS	MIN	TYP	MAX	UNITS
RF Input Frequency		800		2000	MHz
RF Input VSWR	800MHz		-17		dB
	2000MHz		-12		
Output Voltage, 836MHz	-5dBm input		0.88		V
	-25dBm input		0.06		
Output Voltage, 1950MHz	-5dBm input		0.72		V
	-25dBm input		0.06		
Residual Error after Room Temperature Calibration (T _A = -40°C to +85°C) (Note 4)	-5dBm input			±0.5	dB
	-25dBm input			±1.5	

Note 3: Guaranteed by production test at T_A = +25°C. Guaranteed by design and characterization at T_A = -40°C and T_A = +85°C.

Note 4: Guaranteed by design and characterization. See the *Typical Operating Characteristics*.

RF Power Detector

MAX2209

Typical Operating Characteristics

(VCC = 2.8V, typical values are at T_A = +25°C, unless otherwise noted.)

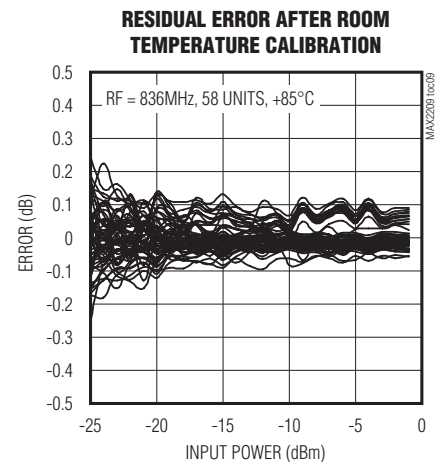
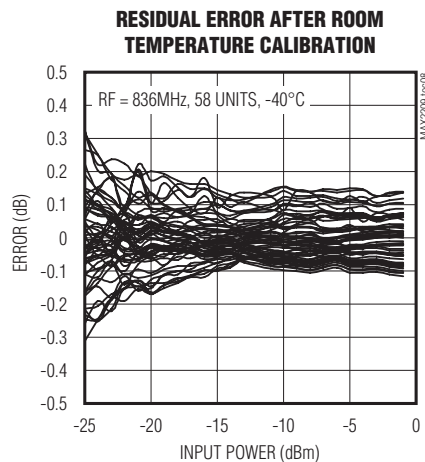
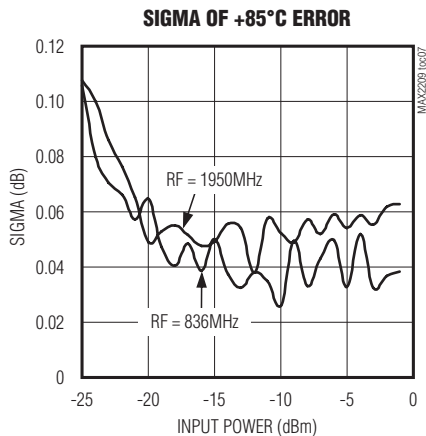
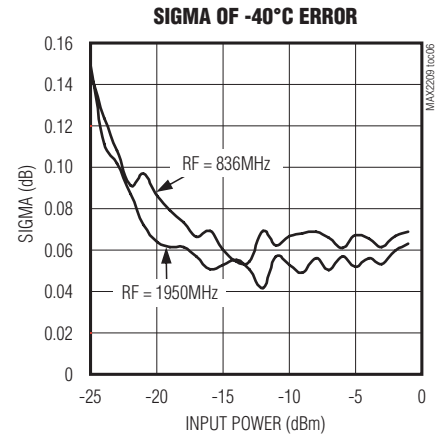
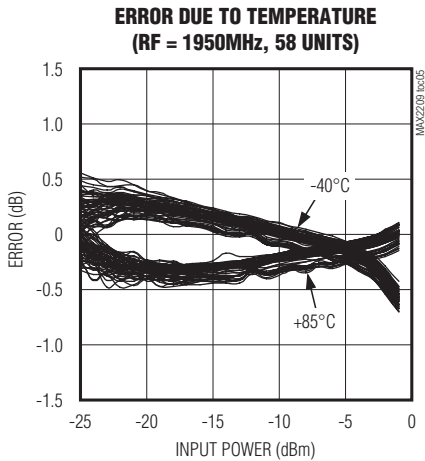
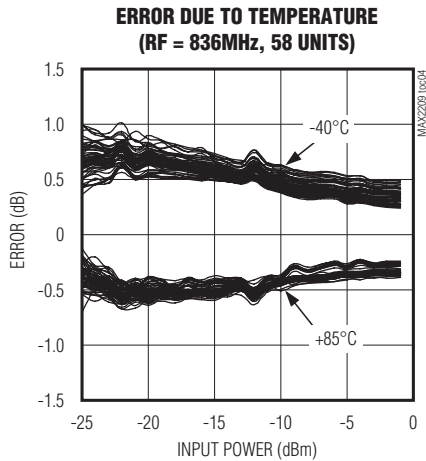
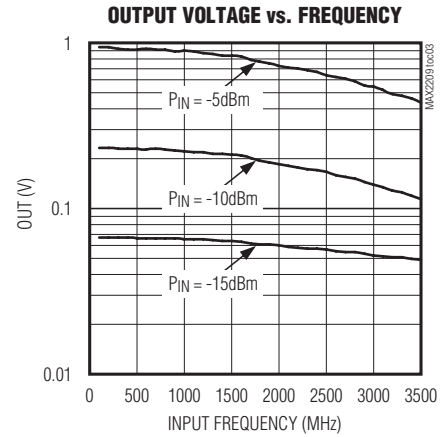
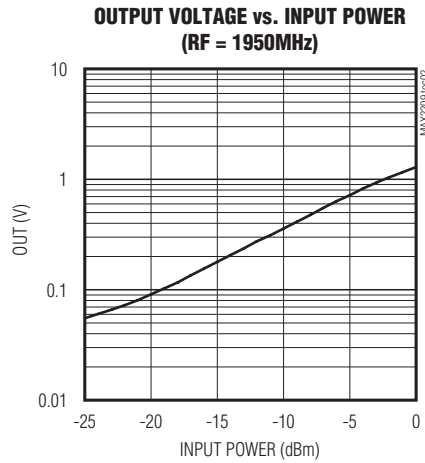
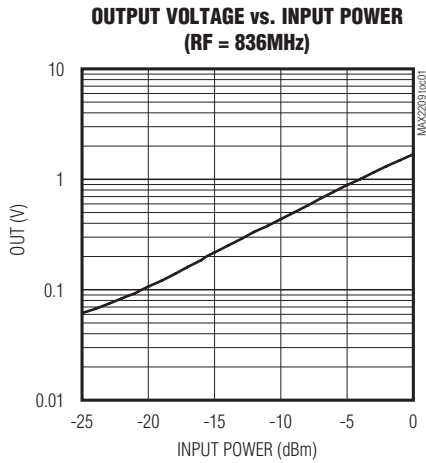

RF Power Detector

Typical Operating Characteristics (continued)

(VCC = 2.8V, typical values are at TA = +25°C, unless otherwise noted.)

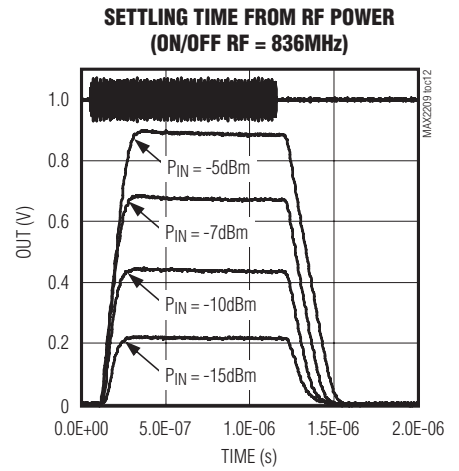
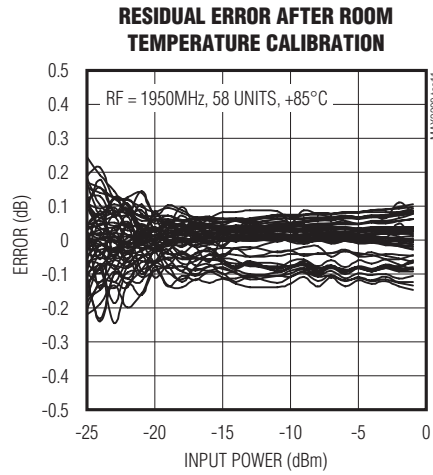
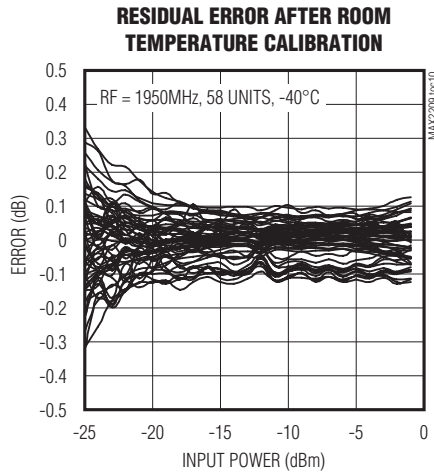

RF Power Detector

MAX2209

Pin Description

BUMP	NAME	FUNCTION
A1	OUT	Detector Output
A2	VCC	Power Supply. Bypass to GND with a capacitor as close as possible to the bump.
B1	GND	Ground Connection. Connect to PCB ground plane with as low inductance as possible.
B2	RFIN	RF Input. Internally terminated to 50Ω. AC-couple the RF input to this pin.

Detailed Description

The MAX2209 power detector is designed to operate from 800MHz to 2.0GHz. The device is ideal for wideband code-division multiple access (WCDMA), cdma2000®, and high-speed downlink/uplink packet access. The MAX2209 accepts an RF signal at the input, and outputs a temperature-independent voltage related to the input signal voltage. The output voltage expressed in dBV is proportional to the input power expressed in dBm. The device has a detection range from -25dBm to 0dBm.

Applications Information

The MAX2209 contains an internal termination resistor for use with directional couplers. The typical application circuit is shown in Figure 1. The output of the detector goes to an ADC for further processing by the baseband system. Connect a series resistor and shunt capacitor to the MAX2209 output to reduce residual amplitude ripple.

Layout

There are two areas that require attention: the GND pin and the supply bypassing. Connect the GND pin to the PCB ground with a GND via as close as possible, and bypass VCC to ground with a capacitor as close as possible to the part.

Chip Information

PROCESS: BIPOLAR

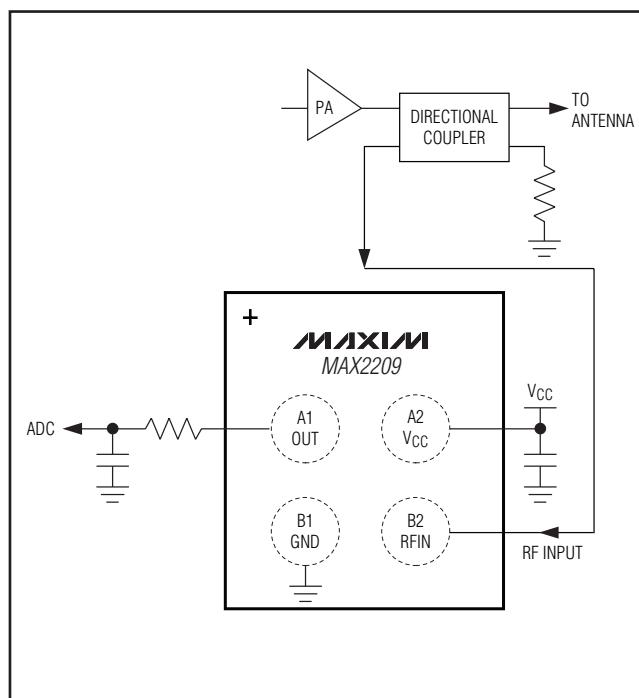

Figure 1. Typical Application Circuit

Package Information

For the latest package outline information and land patterns, go to www.maxim-ic.com/packages. Note that a "+", "#", or "-" in the package code indicates RoHS status only. Package drawings may show a different suffix character, but the drawing pertains to the package regardless of RoHS status.

PACKAGE TYPE	PACKAGE CODE	DOCUMENT NO.
4 UCSP	B4+4	21-0117

cdma2000 is a registered trademark of the Telecommunications Industry Association.

Maxim cannot assume responsibility for use of any circuitry other than circuitry entirely embodied in a Maxim product. No circuit patent licenses are implied. Maxim reserves the right to change the circuitry and specifications without notice at any time.

Maxim Integrated Products, 120 San Gabriel Drive, Sunnyvale, CA 94086 408-737-7600

5