

Panasonic

Panasonic

TXD2-L-1.5V-3

Hlutanúmer:

TXD2-L-1.5V-3

Framleiðandi / Vörumerki:

Panasonic

Vörulýsing

RELAY GEN PURPOSE DPDT 2A 220V

Gagnablöð:

 TXD2-L-1.5V-3.pdf

RoHS Staða

 Leiða frjáls / RoHS samhæft

Ástand á lager

14772 pcs stock

Skip frá

Hong Kong

Sending vegur

DHL/Fedex/TNT/UPS/EMS

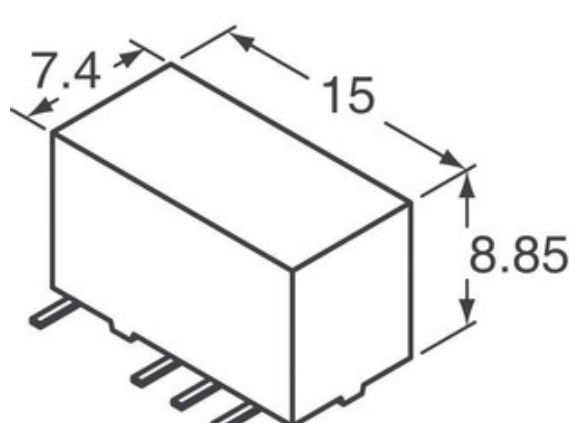

Mynd getur verið fulltrúi. Sjá upplýsingar um upplýsingar um vörur.













Upplýsingar um TXD2-L-1.5V-3

HLUTANÚMÉR	TXD2-L-1.5V-3
FRAMLEIÐANDI	Panasonic
LÝSING	RELAY GEN PURPOSE DPDT 2A 220V
LEIÐA FRJÁLS STAÐA / ROHS STAÐA	Leiða frjáls / RoHS samhæft
MAGN Í BODI	14772 pcs
GÖGN	 TXD2-L-1.5V-3.pdf
KVEIKJA Á SPENNA (HÁMARK)	1.13 VDC
SLÖKKVA Á SPENNU (MIN)	-
UPPSAGNARSTÍLL	PC Pin
SKIPTA SPENNU	220VDC - Max
RÖÐ	TX-D
SLEPPTU TÍMA	4ms
RELAY TYPE	General Purpose
PÖKKUN	Tube
VINNUHITASTIG	-40°C ~ 85°C
STARFAÐU TÍMA	4ms
UPPSETNINGARTEGUND	Through Hole
VÖKTUNARNÆMISSTIG (MSL)	1 (Unlimited)
LEIÐA FRJÁLS STAÐA / ROHS STAÐA	Lead free / RoHS Compliant
LÖGUN	Sealed - Fully
NÁKVÆM LÝSING	General Purpose Relay DPDT (2 Form C) Through Hole
TENGILIÐUR EINKUNN (NÚVERANDI)	2A
SNERTINGAREFNI	Silver (Ag), Gold (Au)
TENGILIÐUR	DPDT (2 Form C)
SPÓLU SPENNA	1.5VDC
SPÓLU TEGUND	Latching, Single Coil
SPÓLUPÓL	10 Ohms
SPÓLUORKA	230 mW
SPÓLU NÚVERANDI	153mA

Svipaðir merkingar

Panasonic TXD2-L-1.5V-3	TXD2-L-1.5V-3 dreifingaraðili	TXD2-L-1.5V-3 Birgir
TXD2-L-1.5V-3 Verð	TXD2-L-1.5V-3 Myndir	TXD2-L-1.5V-3 Image
TXD2-L-1.5V-3 PDF skjal	TXD2-L-1.5V-3 Sækja gagnapakkkann	TXD2-L-1.5V-3 gagnablöð
TXD2-L-1.5V-3 lager	Kaupa TXD2-L-1.5V-3	Kaupa Panasonic TXD2-L-1.5V-3
Panasonic TXD2-L-1.5V-3	Panasonic Birgir	Panasonic dreifingaraðili
Panasonic TXD2-L-1.5V-3	Panasonic - Consumer Division TXD2-L-1.5V-3	Panasonic - Consumer Electronics Corp. TXD2-L-1.5V-3
Panasonic Battery Group TXD2-L-1.5V-3	Panasonic Electric Works - ACSD TXD2-L-1.5V-3	Panasonic Electronic Components - Semiconductor Pr TXD2-L-1.5V-3
Panasonic - ATG TXD2-L-1.5V-3	Panasonic - BSG TXD2-L-1.5V-3	Panasonic - DTG TXD2-L-1.5V-3
Panasonic Electric Works TXD2-L-1.5V-3	Panasonic Electronic Components TXD2-L-1.5V-3	Panasonic Industrial Automation Sales TXD2-L-1.5V-3
Panasonic Semiconductor TXD2-L-1.5V-3		

skyldar vörur

 <p>TXD2-L-24V Framleiðendur: Panasonic Lýsing: RELAY GEN PURPOSE DPDT 2A 220V Á lager: 16075 pcs</p> <p>RFQ</p>	 <p>TXD2-L-12V-3 Framleiðendur: Panasonic Lýsing: RELAY GEN PURPOSE DPDT 2A 220V Á lager: 16506 pcs</p> <p>RFQ</p>
 <p>TXD2-9V Framleiðendur: Panasonic Lýsing: RELAY GEN PURPOSE DPDT 2A 220V Á lager: 23459 pcs</p> <p>RFQ</p>	 <p>TXD2-6V-4 Framleiðendur: Panasonic Lýsing: RELAY GEN PURP DPDT 10MA 10V Á lager: 18481 pcs</p> <p>RFQ</p>
 <p>TXD2-L-1.5V Framleiðendur: Panasonic Lýsing: RELAY GEN PURPOSE DPDT 2A 220V Á lager: 20159 pcs</p> <p>RFQ</p>	 <p>TXD2-L-12V-4 Framleiðendur: Panasonic Lýsing: RELAY GEN PURP DPDT 10MA 10V Á lager: 18417 pcs</p> <p>RFQ</p>
 <p>TXD2-6V-3 Framleiðendur: Panasonic Lýsing: RELAY GEN PURPOSE DPDT 2A 220V Á lager: 18271 pcs</p> <p>RFQ</p>	 <p>TXD2-L-1.5V-4 Framleiðendur: Panasonic Lýsing: RELAY GEN PURP DPDT 10MA 10V Á lager: 17601 pcs</p> <p>RFQ</p>
 <p>TXD2-L-12V-6 Framleiðendur: Panasonic Lýsing: RELAY GEN PURPOSE DPDT 2A 220V Á lager: 4478 pcs</p> <p>RFQ</p>	 <p>TXD2-L-12V Framleiðendur: Panasonic Lýsing: RELAY GEN PURPOSE DPDT 2A 220V Á lager: 19128 pcs</p> <p>RFQ</p>
 <p>TXD2-9V-4 Framleiðendur: Panasonic Lýsing: RELAY GEN PURP DPDT 10MA 10V Á lager: 18858 pcs</p> <p>RFQ</p>	 <p>TXD2-9V-3 Framleiðendur: Panasonic Lýsing: RELAY GEN PURPOSE DPDT 2A 220V Á lager: 18632 pcs</p> <p>RFQ</p>

